

 **LORIENT**

**ASSA ABLOY**

**ACOUSTIC SEALING  
SYSTEMS FOR DOOR  
ASSEMBLIES**

ACOUSTIC SEALING SYSTEM



**ASSA ABLOY**

## We've been designing and manufacturing high performance sealing systems for over 40 years.

And we're passionate about the products we make. Our dedicated R&D and testing facilities rigorously put our sealing systems through their paces – enabling us to enhance product form and function. We've built a strong reputation for design innovation; and for producing the highest quality sealing systems embracing acoustic, smoke, fire and thermal containment; as well as accessibility.

Respected throughout the industry for our technical expertise, we play an active role in helping to shape standards and best practice.

We believe in providing excellent levels of customer service; and are at our best working in partnership with you.



## ICONS EXPLAINED

The following icons are used throughout this brochure to give clear and easy recognition of a particular seal's function or possible application. Use of the icons does not necessarily indicate that test evidence exists. Refer to product system specification for relevant test evidence, or please check with the Lorient Technical team.



Fire protection



Smoke protection



Acoustic protection



Draught protection



Dust protection



Wheelchair friendly



Light protection



Thermal containment properties



Weather protection



[www.lorientuk.com/acousticsearch](http://www.lorientuk.com/acousticsearch)

Our Acoustic Search tool provides quick and easy access to a wide range of tested acoustic sealing systems on a variety of popular door constructions and configurations.

## PRODUCT ILLUSTRATIONS

All dimensions in this brochure are in millimetres.

## CONTENTS

01

Introduction

03

Sealing Solutions

04

Featured Products

07

Sealing Doors Worldwide

09

Principles of Acoustics

11

Acoustics for Door Assemblies

13

Building Regulations

14

Standards + Regulations

15

Fire Door Rating

16

Sound Containment

17

Acoustic Testing Procedures

19

Sealing Systems Explained

21 – 24

29-30dB Solutions

25 – 30

31-34dB Solutions

31 – 36

35dB Solutions

37 – 44

40dB+ Solutions

46

Testing + Technical Services

47

Additional Information

49

CPD Seminars

51

Comprehensive Support

# SEALING SOLUTIONS



Find acoustic solutions in our online Acoustic Search app: [www.lorientuk.com/acousticsearch](http://www.lorientuk.com/acousticsearch)

dB Rating	Door configuration		Sealing system			Protection					Page	
	Door	Thickness	Perimeter	Meeting stile	Threshold							
<b>29dB</b>	Single	44mm	LAS1212 LP1504	—	LAS8001 si	▲	▲	▲	▲	▲	ID2	<b>20</b>
<b>29dB</b>	Single	44mm	LAS7001 si	—	LAS8001 si LAS4002	▲	▲		▲	▲	ID221	
<b>29dB</b>	Double	44mm	LP2004DS	LP1504 x 2 LAS1011 x 2	LAS8001 si LAS4002	▲	▲	▲	▲	▲	ID277	
<b>30dB</b>	Single	44mm	LP1504 Finesse™	—	LAS8002 si	▲	▲	▲	▲	▲	ID130	<b>21</b>
<b>30dB</b>	Double	44mm	LAS1212	LAS1011 x 2	LAS8001 si LAS4012	▲	▲		▲	▲	ID348	
<b>31dB</b>	Single	44mm	LP1504 LAS7005	—	LAS8001 LAS4002	▲	▲	▲	▲	▲	ID141	
<b>31dB</b>	Double	44mm	LAS7001 si	LAS1011	LAS8001 si LAS4002	▲	▲		▲	▲	ID262	<b>24</b>
<b>32dB</b>	Double	54mm	LAS1212 LP1504 x 2	LP1504DS x 2	LAS8001 si LAS4002	▲	▲	▲	▲	▲	ID23	<b>25</b>
<b>32dB</b>	Double	44mm	LAS1212	LAS1011 x 2	LAS3001 LAS4012	▲	▲		▲	▲	ID350	
<b>33dB</b>	Single	44mm	LP1504DS	—	LAS8001 si	▲	▲	▲	▲	▲	ID29	<b>26</b>
<b>33dB</b>	Double	44mm	LAS1212 LAS1011	LAS1011 x 2	LAS8003 si LAS4002	▲	▲		▲	▲	ID550	<b>27</b>
<b>33dB</b>	Double	54mm	LAS1212	LP1504DS	LAS8001 si LAS4002	▲	▲	▲	▲	▲	ID146	
<b>34dB</b>	Single	44mm	LP1504DS	—	LAS8001 si	▲	▲	▲	▲	▲	ID35	<b>28</b>
<b>35dB</b>	Single	54mm	LP1504DS x 2	—	LAS8001 si	▲	▲	▲	▲	▲	ID72	<b>32</b>
<b>35dB</b>	Single	54mm	LP1504DS	—	LAS8040	▲	▲	▲	▲	▲	ID109	
<b>35dB</b>	Single	44mm	LAS1212K LP1504DS	—	LAS8001 si	▲	▲	▲	▲	▲	ID64	<b>33</b>
<b>35dB</b>	Single	54mm	LP1504DS x 2	—	LAS8001 si	▲	▲	▲	▲	▲	ID484	
<b>35dB</b>	Single	54mm	LAS1212 LP1504DS	—	LAS8001 si	▲	▲	▲	▲	▲	ID552	<b>35</b>
<b>35dB</b>	Double	54mm	LAS1212 LAS1011	LAS1011 x 2	LAS1016 x 2 LAS4002	▲	▲		▲	▲	ID162	<b>34</b>
<b>35dB</b>	Double	54mm	LAS1212K LP1504	AAS7506	LAS4014 si	▲	▲	▲	▲		ID77	<b>36</b>
<b>37dB</b>	Double	44mm	LAS1212 LAS1011	LAS1011	LAS8001 si	▲	▲		▲	▲	ID545	
<b>40dB</b>	Single	44mm	LP1504DS LAS1212	—	LAS8040	▲	▲	▲	▲	▲	ID507	
<b>40dB</b>	Single	52mm	LAS6001 LAS6011	—	LAS8001 LAS4012	▲	▲		▲	▲	ID334	
<b>40dB</b>	Single	45mm	LAS7003 si	—	LAS8001 si LAS4014 si	▲	▲		▲		ID551	<b>41</b>
<b>40dB</b>	Double	54mm	LP1504DS x 2	LP1504DS x 2	LAS1016 x 2 LP1504 LAS4012	▲	▲	▲	▲	▲	ID95	<b>40</b>
<b>40dB</b>	Double	45mm	LAS1212	LAS1011 x 2	LAS8001 si LAS4014 si	▲	▲		▲		ID553	<b>42</b>
<b>41dB</b>	Single	44mm	LAS1010 LP1504DS	—	LAS1011 x 2 LAS4010	▲	▲	▲	▲	▲	ID96	<b>43</b>
<b>41dB</b>	Double	59mm	LP1504DS x 2	LP1504DS x 2	LAS1016 x 2 LAS4010	▲	▲	▲	▲	▲	ID98	<b>44</b>
<b>42dB</b>	Single	52mm	LP1504DS LAS1212	—	LAS8001 si LAS4014 si	▲	▲	▲	▲		ID327	
<b>42dB</b>	Double	59mm	LP1504DS x 2	LP1504DS x 2	LAS1016 x 2 LAS4012	▲	▲	▲	▲	▲	ID99	
<b>43dB</b>	Single	44mm	LAS1010 LP1504DS	—	LAS1016 x 2 LAS4010	▲	▲	▲	▲	▲	ID101	<b>45</b>
<b>44dB</b>	Single	54mm	LP1504DS LAS1010	—	LAS1011 x 2 LAS4011	▲	▲	▲	▲	▲	ID105	

# FEATURED PRODUCTS

## PERIMETER SEALS

Please note illustrations are not to scale and for reference only.

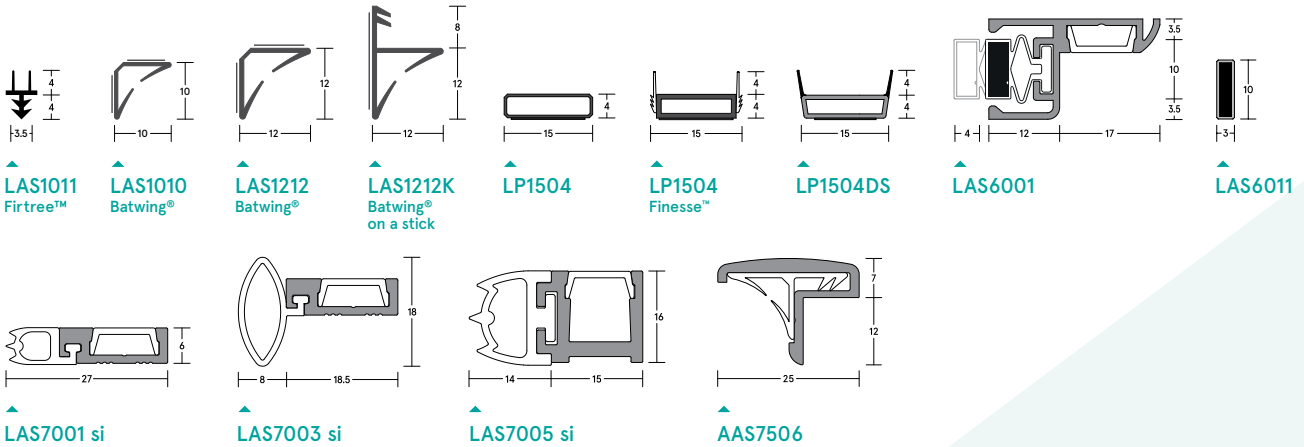

## THRESHOLD PLATES

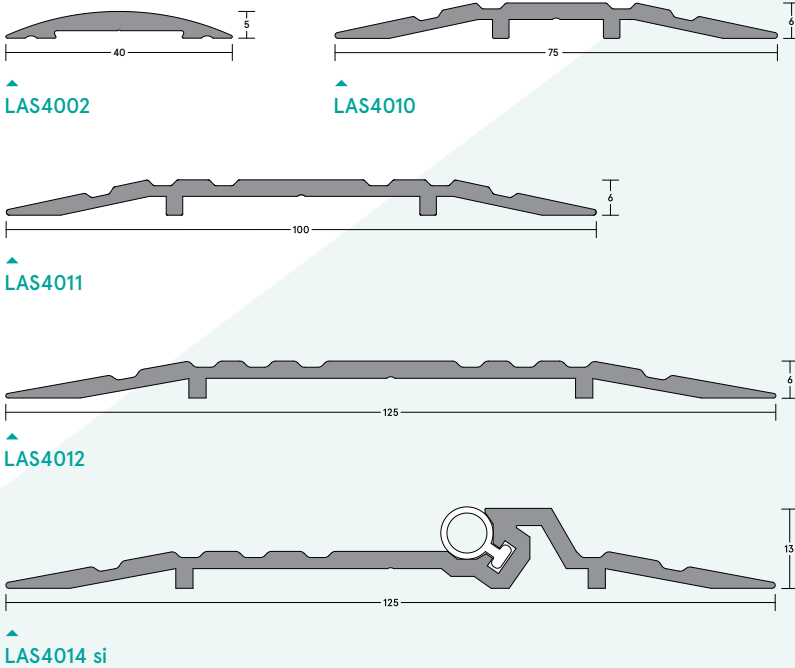

## DROP SEALS

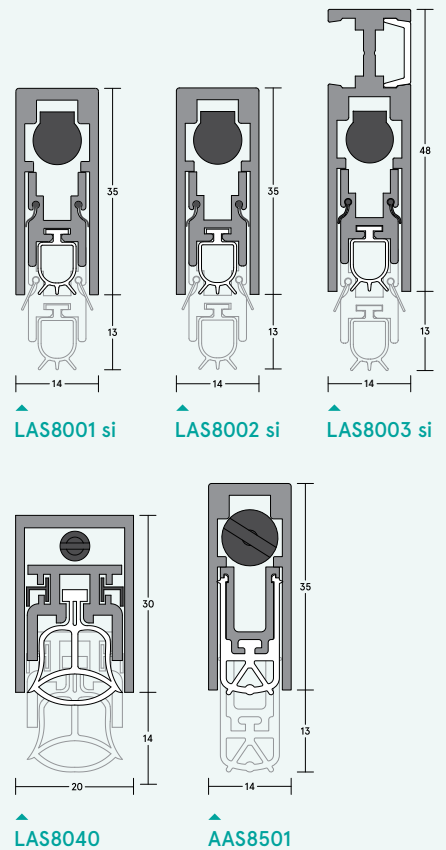

## GLAZING RETENTION SYSTEMS

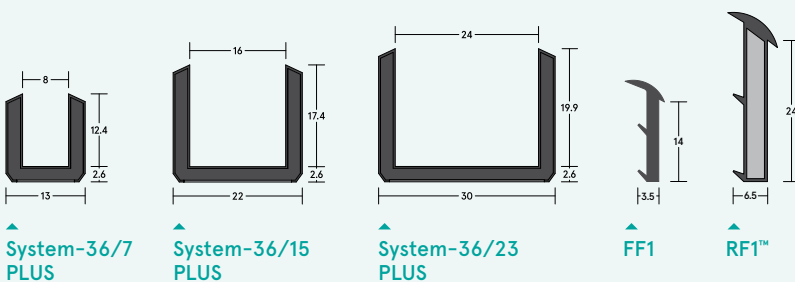

## DOOR BOTTOM SEALS

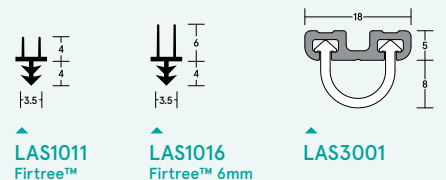

A large teal triangle graphic that points downwards from the top left corner of the page, covering the left and bottom portions of the cover.

# SEALING SYSTEMS, CREATING SOLUTIONS

ACOUSTIC  
SEALING SYSTEMS  
FOR DOOR  
ASSEMBLIES

**One of the many reasons professionals choose Lorient when specifying acoustic door seals is trust. Comprehensive guidance you can trust to ensure accurate specification. Products you can trust to perform at the specified level, today and every day.**

**The ideal system for any door assembly is defined by that door's type, location and intended use. Different doors have different strengths and weaknesses. The test data we supply for our products are never generic, they only ever apply to a particular doorset (material and configuration), working together with a set of system components to achieve specific performance.**

Our comprehensive range of sealing systems will:

- ▶ fill gaps around the door and prevent the transfer of unwanted noise.
- ▶ work with your door assembly to improve aspects of its performance.
- ▶ add minimal resistance to the opening and closing operation of the door.
- ▶ perform reliably in real world use for many years to come.
- ▶ enhance quality of life through preservation of privacy.

We've only featured a select number of acoustic sealing systems in this brochure, but there are many, many more. Our extensive library of evidence can be found on our website using our web application. Simply visit our website [www.lorientuk.com](http://www.lorientuk.com) or speak to one of our Technical Services Advisors who will be more than happy to help.



**Talk to us +44 (0) 1626 834252**

 **LORIENT**

---

**ASSA ABLOY**

# SEALING DOORS WORLDWIDE

**The UK is home to our head office, manufacturing operation and dedicated R+D testing facility. Our UK & Europe head office supports operations around the world, delivering the best solutions locally to our customers across four continents.**

By keeping abreast of technical developments and changes to regulations and standards across the world, we deliver the highest levels of expertise and support.



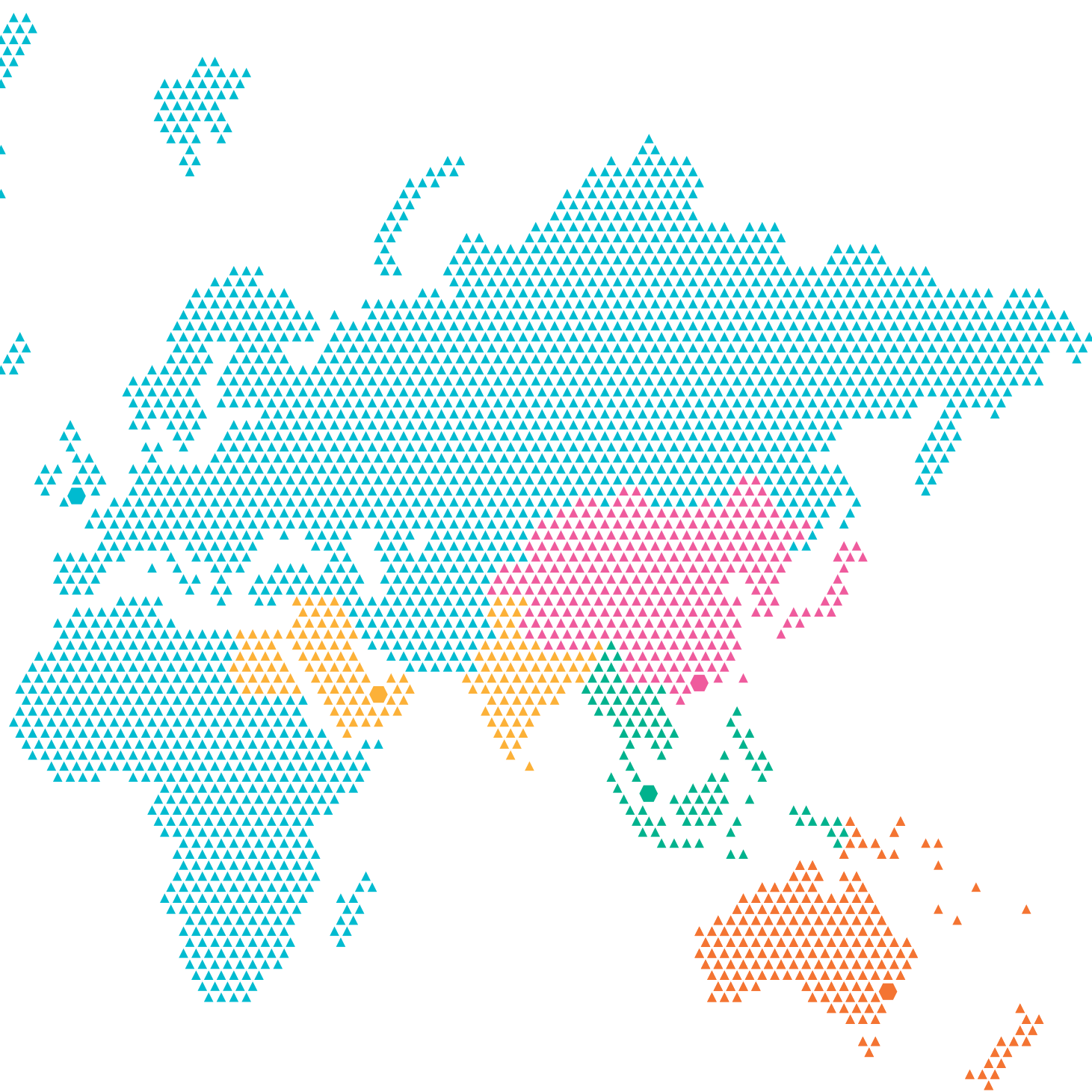

UNITED KINGDOM (HQ)

AUSTRALIA

SINGAPORE

HONG KONG

USA

UAE

# PRINCIPLES OF ACOUSTICS

Sound is the sensation perceived by the human ear, resulting from very rapid fluctuations in air pressure. These tend to take the form of a longitudinal wave.

Sound can be transmitted through almost any medium – solids, liquids or vapours. Within buildings, sound can be either structure borne (such as footsteps, hammering or impact noise passing through the fabric of the building); or airborne. Door leaves respond to airborne sound.

Airborne sound is transferred through air by the oscillation of air molecules. A repeated sequence of compressions and rarefactions in the air sets up a wave – the sound wave – which is directly related to the sound source.

The number of vibrations per second of the wave is termed "frequency", and is measured in Hertz. 1Hz = 1 cycle per second. This is a very low frequency, in terms of everyday acoustics we usually work in the range of 50 – 5,000Hz.

Sound also has power, which is measured in Watts. The human ear is sensitive to both frequency and sound power, and therefore the unit of measurement for acoustics must take both of these into account. The term decibel (dB) is used, which measures sound pressure, and strictly speaking it is a measure of comparison between two levels of sound intensity, generally a reduction.

- ▶ **dB** = sound pressure comparison between two points.
- ▶ **dB(A)** = an expression of the relative loudness of sound in air as perceived by the human ear. The A-weighted filter corresponds to the fact that the human ear is not as sensitive to sound at the lower frequencies as it is at the higher frequencies.
- ▶ **Rw** = Weighted Sound Reduction Index. A single figure performance indicator derived from measurements over a range of frequencies in accordance with BS EN ISO 717-1.
- ▶ **STC** = Sound Transmission Class. A single figure performance indicator very similar to Rw but derived from ASTM-E413 Classification for rating sound insulation.

It should be noted that the dB measurement scale is logarithmic, thus a change from 10dBA to 20dBA means that the sound is not just twice, but 10 times more intense.

Human beings are highly adapted to the physical phenomena of light, heat and sound – although our sensitivity varies widely.

The human ear can detect levels as low as 20dBA (the rustle of leaves) and tolerate intense noises for short periods without any ear protection, such as the jet engine at around 120dBA.

But while these figures are interesting, we should not only be concerned about keeping out loud noises; but we should also be aware of the importance of quiet noise and duty of care where privacy is concerned, such as in the Doctors surgery.

Sound level dBA (Log Scale)	Sound Source
0	▶ Threshold of audibility
20	▶ Whisper
30	▶ Quiet conversation
40	▶ Background noise in an unoccupied office
50	▶ Normal conversation
60	▶ Occupied offices
70	▶ Inside a railway carriage
80	▶ Roadside, a busy street
100	▶ Inside a nightclub
120	▶ Jet aircraft taking off 100m away or MP3 player at maximum volume
120-130	▶ Threshold of pain
140+	▶ Damage to hearing

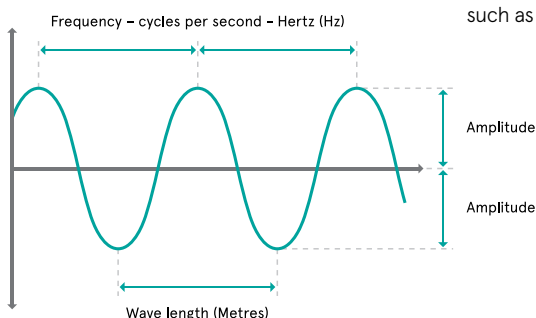

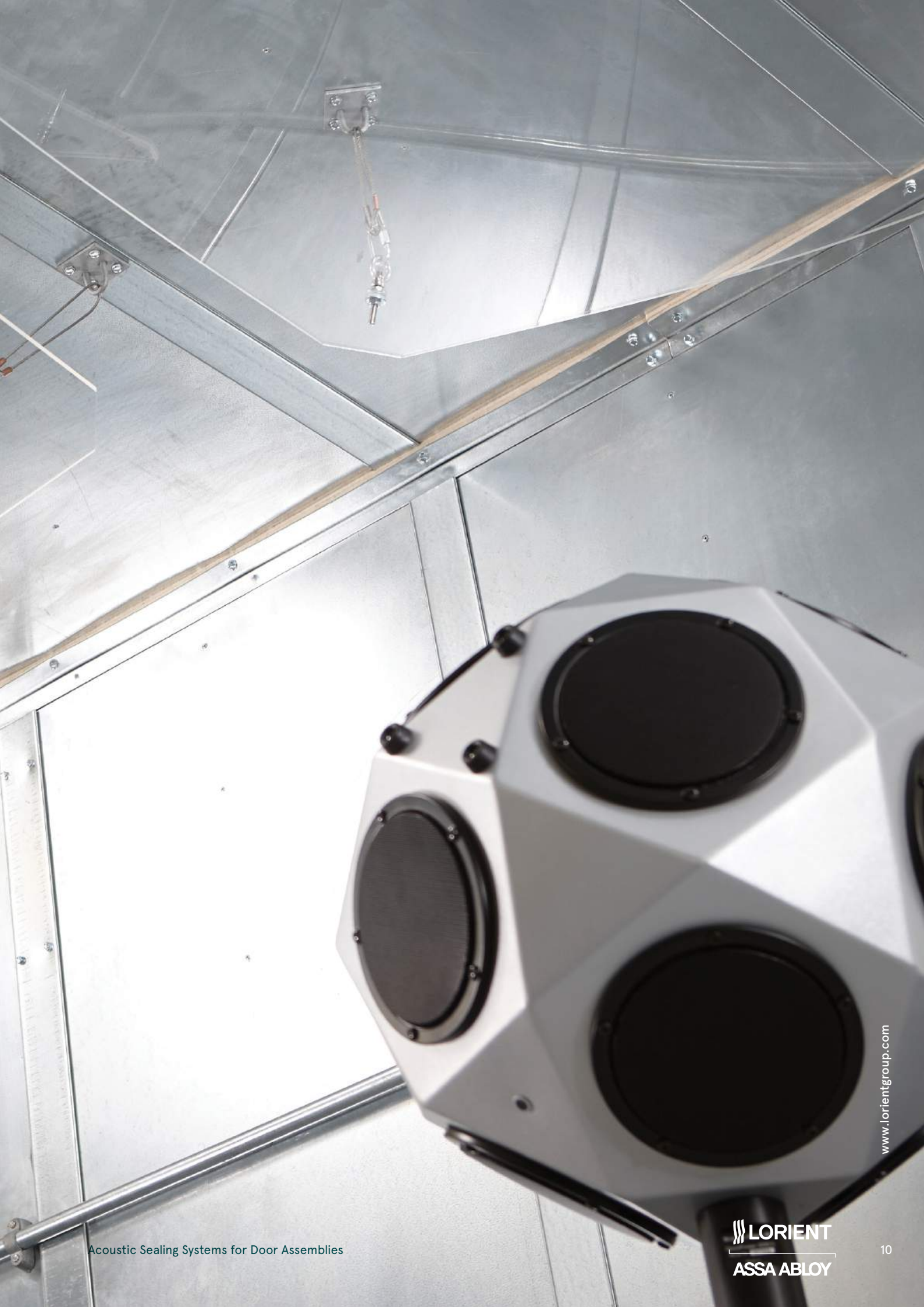

# ACOUSTICS FOR DOOR ASSEMBLIES

Door assemblies are an integral part of buildings and while there must be gaps around the perimeter of doors for them to operate efficiently, these gaps allow sound to pass through.

## Door assemblies

Sealing the gaps around a door is therefore crucial to reduce the amount of sound entering or leaving a room.

When fitted to external doors, Lorient seals help to isolate buildings from noise generated by roads, railways and airports. When fitted to internal doors, they help to isolate rooms from airborne noise generated within a building and so are ideal for auditoria, offices, consultation and conference rooms, colleges and universities, hotel bedrooms and individual apartments in communal dwellings; in fact – for most buildings.

## Acoustic sealing systems

**A door assembly needs to be separately designed and evaluated for its acoustic performance. Many doors that provide acoustic containment may also have to provide fire and smoke resistance.**

Door assemblies respond to airborne sound (such as conversation or music), rather than structure-borne sound (such as footsteps or hammering). To reduce the amount of sound passing from one side to the other, we need to consider two things – the door leaf construction and the sealing system.

## Sealing system principles

A door leaf will vibrate when sound hits it, and those vibrations transfer the sound from one side to the other. Sound can also pass through any gaps around the edges of the door – deep door stops or rebated edges won't make a difference to the amount of sound transferred.

Lorient manufactures seals for all four sides of the door, to provide a complete and continuous barrier around the door when it is closed – maintaining the acoustic integrity of the doorset.

The sealing system may also control the transfer of draughts, dust, smoke and fire. Smoke and fire are particularly important, as many acoustic doors in a building will probably need to be fire and smoke resisting too, due to their location. With careful selection, just one sealing system can perform all these tasks.

For lower performances (typically up to  $R_w$  30dB), simple sealing systems can generally be used. For higher performances of  $R_w$  35dB and above, additional or specialist sealing is often required.

## There are two main types of Acoustic seal

It is important to seal all four sides of the door using the following:

Perimeter Seals (such as the DS or Batwing®) – designed to seal the perimeter of the door leaf generally at the head, jambs and meeting stiles.

Threshold Seals (such as LAS8001 si drop seal & LAS4001 threshold plate) – designed to seal the gap between the bottom edge of the door and the floor.

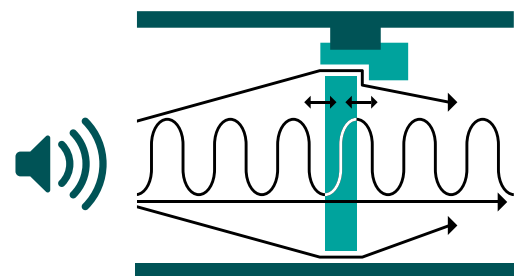

Sound passing through and around a door assembly

## Factors affecting performance of Door Designs

When specifying a sealing system, it's important to take account of all the factors that can impact on performance:

### On-site conditions

While laboratory testing provides standardised data for comparative purposes, site conditions need to be considered. Wall, floor or ceiling construction, workmanship and installation methods can all affect the final performance.

### Glazed panels

These can be incorporated without a significant loss of acoustic performance and in some cases can improve the sound insulating properties, provided that the area of glass in relation to area of door and thickness of glass being used is considered.

### Operating forces

It is crucial that a sealing system should have minimal effect on the opening and closing operation of a door assembly.

### Ironmongery

Interrupting a smoke or acoustic door seal at hinges or other ironmongery points can seriously compromise effectiveness. It's vital to ensure a continuous seal all around the door.

### Letter plate apertures

Lorient letter plates are suitable for use on most types of solid timber door construction, and have been proven not to cause any significant reduction to the overall acoustic performance of the door.

### Stops

The use of stop-mounted seals or perimeter seals that replace stops requires careful attention. This is especially relevant where the use of drop seals is being considered.

### Trip hazards

A stepped threshold provides higher sound attenuation, but due to safety considerations these are usually only suitable in low traffic locations, such as plant rooms.

### The threshold

Effective sealing between the bottom of the door and the floor is essential to meet the performance requirements for acoustic doors.



### Brush seals

Conventional brush type seals are not suitable for acoustic containment, the fibres of the brush are fairly porous and will let airborne sound pass through.

Lorient's fin seal technology has been proven to deliver superior acoustic performance when compared to a brush type seal; while also offering low frictional resistance and high durability. A brush type seal will not provide the levels of acoustic performance as detailed in Approved Document E, nor will they provide the low frictional resistance required by Approved Document M.

For optimum acoustic, smoke, fire and thermal containment performance, coupled with outstanding properties of low friction and durability, Lorient's DS or Finesse™ should always be specified.

Tests were undertaken on a typical FD30S door assembly with a laminated softwood core and in conjunction with the LAS8001 si drop seal. These tests proved that smoke seals with elastomeric fins provide far superior acoustic performance.

Product Code	Acoustic Performance
	Weighted Sound Reduction Index (Rw)
LP1504 Finesse™	31dB
	
LP1504 DS	31dB
	
LP1504 SS	23dB
	

# BUILDING REGULATIONS

The Building Regulations provide guidance as to the minimum building standards to be achieved. They reference the relevant British and European Standards defining the test requirements and performance of the fire door assembly or fire doorset.

There are several aspects of the Buildings Regulations that must be considered in conjunction with each other when specifying and installing fire and smoke resistant door assemblies. The regional variations of the Building Regulations:

	ENGLAND	WALES	SCOTLAND	N.IRELAND	IRELAND
<b>FIRE</b>	Approved Document B	Approved Document B	Technical Handbook 2	Technical Booklet E	Technical Guidance Document B
<b>ACOUSTICS</b>	Approved Document E	Approved Document E	Technical Handbook 5	Technical Booklet G	Technical Guidance Document E
<b>ACCESSIBILITY</b>	Approved Document M	Approved Document M	Technical Handbook 4	Technical Booklet R	Technical Guidance Document M
<b>THERMAL</b>	Approved Document L	Approved Document L	Technical Handbook 6	Technical Booklet F	Technical Booklet F



# STANDARDS + REGULATIONS

The requirements for fire and smoke containment with regard to 'means of escape' are contained in the following standards:

## FIRE + SMOKE

STANDARD	TITLE
<b>BS 476-20:1987</b>	Fire tests on building materials and structures. Method for determination of the fire resistance of elements of construction (general principles)
<b>BS 476-22:1987</b>	Methods for determination of the fire resistance of non-loadbearing elements of construction doorsets and shutter assemblies. Method of measurement under ambient temperature conditions
<b>BS 476-31.1:1983</b>	Fire tests on building materials and structures. Methods for measuring smoke penetration through doorsets and shutter assemblies. Method of measurement under ambient temperature conditions
<b>BS EN 1634-1:2014+A1:2018</b>	Fire resistance and smoke control tests for door and shutter assemblies, openable windows and elements of building hardware. Fire resistance test for door and shutter assemblies and openable windows
<b>BS EN 1634-3:2004</b>	Fire resistance and smoke control tests for door and shutter assemblies, openable windows and elements of building hardware. Smoke control test for door and shutter assemblies
<b>BS 8214:2016</b>	Timber-based fire door assemblies. Code of practice
<b>BS 9999:2017</b>	Code of practice for fire safety in the design, management and use of buildings

## ACOUSTIC

STANDARD	TITLE
<b>BS EN ISO 10140-1:2021</b>	Acoustics. Laboratory measurement of sound insulation of building elements. Application rules for specific products
<b>BS EN ISO 717-2:2020</b>	Acoustics. Rating of sound insulation in buildings and of building elements. Impact sound insulation elements of construction
<b>ASTM E413-16</b>	Classification for Rating Sound Insulation

# FIRE DOOR RATING

Fire doors are tested to BS 476-22 or BS EN 1634-1 to represent how they will function in a fire, and are rated in minutes and prefixed by the letters FD. The most common specification for fire doors leading to escape routes are fire doors resisting fire for 30 minutes, called FD30 fire doors.

BRITISH STANDARD: MINIMUM FIRE RESISTANCE (INTEGRITY) RATING	EUROPEAN STANDARD: MINIMUM FIRE RESISTANCE (INTEGRITY) RATING	NUMBER OF MINUTES THAT THE DOOR CAN RESIST FIRE
FD30	E30	30 minutes
FD60	E60	60 minutes
FD90	E90	90 minutes
FD120	E120	120 minutes

Sometimes doors are required to be both fire and smoke control (resistant) doors - tested to BS 476-31.1 or EN 1634-3. This means there will be either a combined fire and smoke seal; or a plain intumescent seal along with a separate smoke seal in either the entire perimeter of the door and/or in the frame.

If an air transfer grille (ATG) is required in a fire and smoke control door leaf, it should be fitted with an automatic smoke damper that will close if a fire breaks out.

**The 'S' suffix (e.g. FD30S) denotes that the door is both a fire and smoke controlled door.**

BRITISH STANDARD: MINIMUM FIRE RESISTANCE (INTEGRITY) RATING	EUROPEAN STANDARD: MINIMUM FIRE RESISTANCE (INTEGRITY) RATING	NUMBER OF MINUTES THAT THE DOOR CAN RESIST FIRE + SMOKE
FD30S	E30S	30 minutes
FD60S	E60S	60 minutes
FD90S	E90S	90 minutes
FD120S	E120S	120 minutes



# SOUND CONTAINMENT

Wherever noise influences human activity, effective acoustic sealing is essential. Whether preserving the confidentiality of discussions in a private office or doctor’s surgery, or reducing noise from adjacent rooms in hotels; preservation of privacy is paramount. Legislation is in place that provides guidelines for acoustic performance of door assemblies in a number of situations.

ACOUSTIC RATING	LOCATION	REGULATIONS
<b>29dB Rw</b>	Dwelling houses, flats and rooms for residential purposes	Approved Document E
<b>30dB Rw</b>	Schools: all spaces except music rooms	Building Bulletin 93 "The Acoustic Design of Schools"
<b>35dB Rw</b>	School music rooms	Building Bulletin 93 "The Acoustic Design of Schools"



Approved Document E and Building Bulletin 93 for Schools

# ACOUSTIC TESTING PROCEDURES

The only way to determine the performance of a particular doorset design is to test that product, installed into a structure in a manner that replicates precisely the methods intended for use.

## How we test our products

**We test the acoustic properties of each doorset and sealing system combination in our acoustic transmission suite in accordance with BS EN ISO 10140.**

The test involves installing the assembly (door/window etc) within a dividing wall between a sound source room and a receiving room. Sound waves across the full frequency range are produced in the source room. The receiving room measures the sound pressure level. The difference between the sound pressure levels recorded in each room is determined as the Sound Reduction in index (R).

The Sound Reduction Index is an expression of the laboratory sound transmission performance of a particular element or construction. It is a function of the mass, thickness, sealing method and overall area of sample.

A series of tests will usually include measurement of a 'fully caulked' doorset. This is a test carried out using high density sealing (caulking) material to fill all gaps and provides a useful reference for the efficiency of a particular sealing system.

Lorient test programmes are conducted with a range of common door cores, tested in real door scenarios, for example with an accepted industry gap size of 3-4mm. All Lorient sealing systems are acoustically tested in everyday operational mode and many are tested with long vision panels to meet the requirements of Approved Document M.

**Rest assured that all information in this brochure has been derived from full size door assemblies.**

A third party certificated timber doorset is the best guarantee that all elements – ironmongery, fire and smoke seals and glazing – are fully tested to the relevant standards.

For specialist doors and door blanks, it is essential to consult the manufacturer to determine which seals have been tested. Our Acoustic Search tool on our website provides quick and easy access to a wide range of tested acoustic sealing systems on a variety of popular door constructions and configurations.



Acoustic transmission suite

## Acoustic performance graphs

The sound reduction performance of a given sealing system will vary according to the incident frequency of the sound waves to which it is exposed. The performance graphs used in this brochure convey a clear picture of the characteristic of the various sealing systems over a wide range of incident sound frequencies.

While single-figure  $R_w$  or STC ratings are useful for generalised comparisons, the graphs provide a better specific guide, particularly if a known, narrow band of sound frequencies needs to be controlled. In all cases the graphs show the performance of the door assembly, fitted with the chosen sealing system. The graphs show indicative sound curves over a range of frequencies.

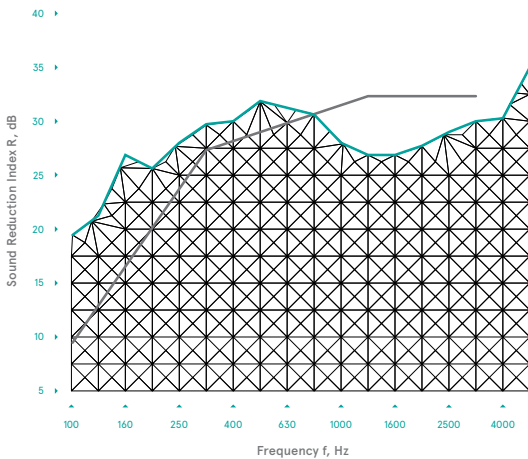

— SOUND REDUCTION INDEX  
 — CURVE OF REFERENCE VALUES (BS EN ISO 717-1: 2013)  
 Tested in accordance with BS EN ISO 10140-2: 2010

## Door constructions

For testing purposes, a variety of door types in common use around the world was chosen as follows:

- ▶ Extruded chipboard core
- ▶ Solid chipboard / particle board core
- ▶ Laminated timber core
- ▶ High density acoustic core
- ▶ Flaxboard rail & stile construction
- ▶ Layered acoustic core

For steel door solutions – contact our technical services team.

 Search for acoustic solutions using our online Acoustic Search app [lorientuk.com/acousticsearch](http://lorientuk.com/acousticsearch)

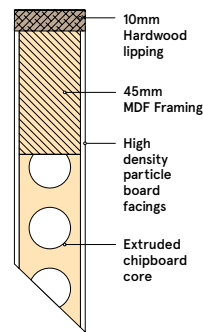

Extruded chipboard core

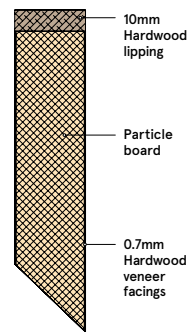

Solid chipboard / particle board core

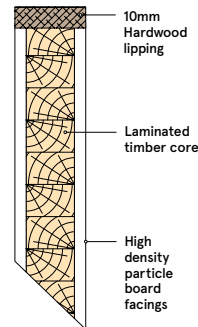

Laminated timber core

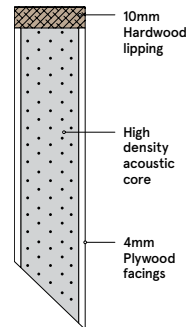

High density acoustic core

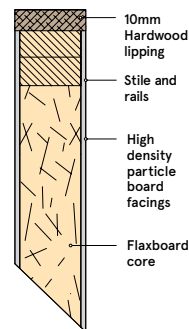

Flaxboard rail & stile construction

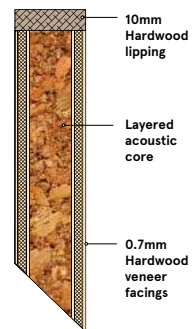

Layered acoustic core

# SEALING SYSTEMS EXPLAINED

The sealing systems presented in this brochure cover a wide range of different applications including both commonly specified and specialist doorsets. However, our comprehensive library of evidence is available on our Acoustic Search app: [lorientuk.com/acousticsearch](http://lorientuk.com/acousticsearch)

The sealing systems are grouped into four sections starting with systems that are designed to provide a weighted sound reduction index of  $R_w$  29dB and rising to systems capable of  $R_w$  44dB.

Each system consists of several (usually 2-5), products, working together around a specific doorset to achieve the desired performance. The illustrations show each product in the system, in situ and clearly labelled to aid easy specification.



Search for acoustic solutions using our online Acoustic Search app  
[lorientuk.com/acousticsearch](http://lorientuk.com/acousticsearch)

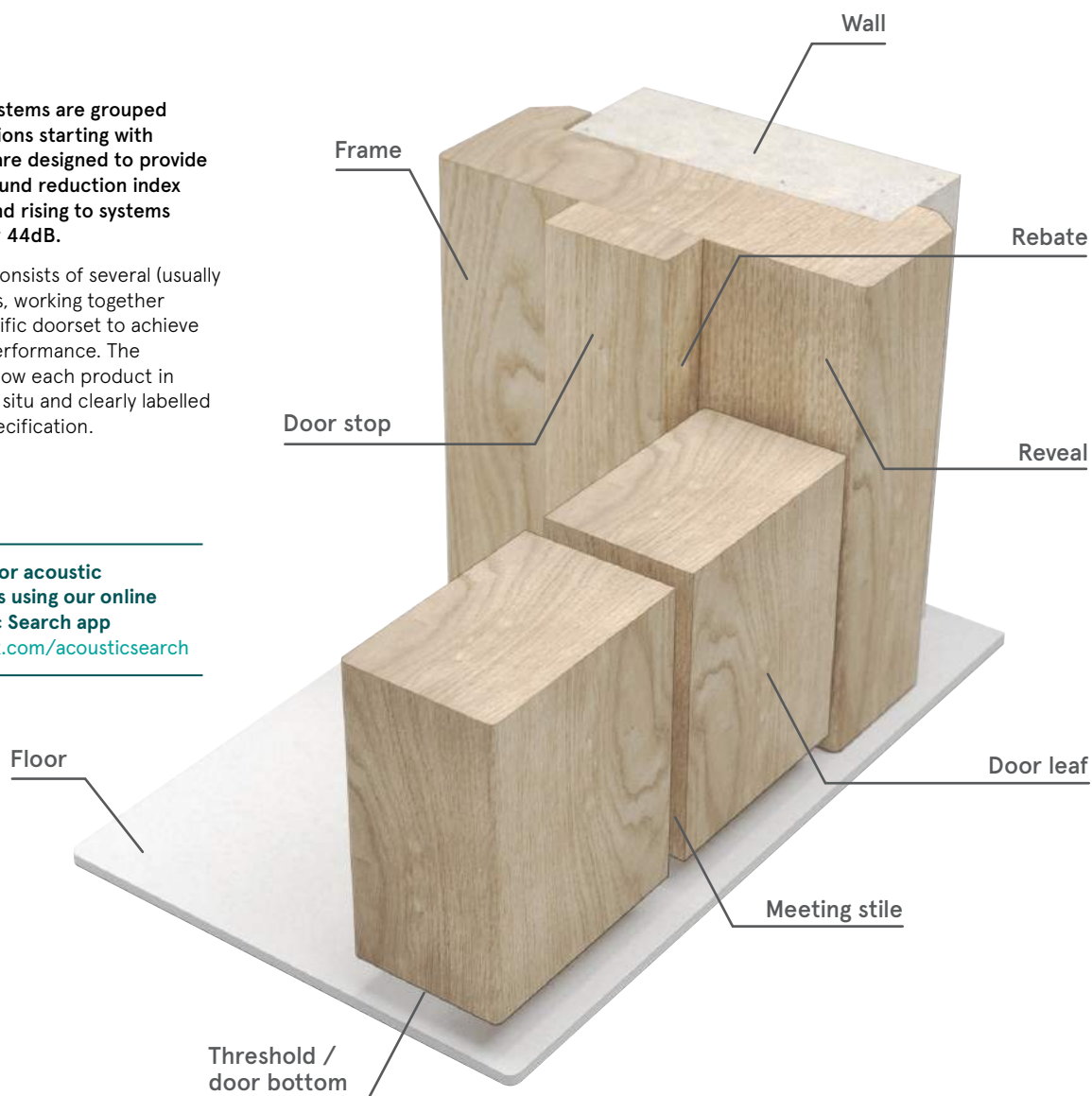

## Location of perimeter seals

An acoustic seal will generally be located in the reveal of the door frame as shown, bridging the gap between the frame and leaf. This is especially true if it is combined with an intumescent seal, such as the DS seal – which provides acoustic, smoke, fire and thermal energy containment.



▲ DS shown with LAS8001 si

Non-intumescent acoustic seals will be located on the door stop, either surface mounted and just touching the face of the door leaf in the closed position, or in the rebate corner. The popular Batwing® acoustic and smoke perimeter seal is located in the rebate corner.



▲ Batwing® seal shown with LAS8005 si

## Meeting stile seals

An astragal is a surface-mounted vertical cover strip designed to conceal the gap between the meeting stiles of single-acting, non-rebated, double leaf doors.

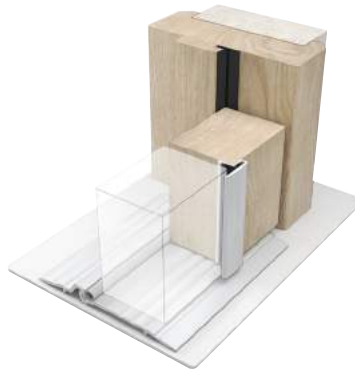

▲ AAS7506 shown with LAS1212K, LAS4014 si

## Threshold seals

Effective sealing of the threshold gap is absolutely necessary to meet the performance requirements for acoustic seals. A drop seal such as the LAS8001 si is the preferred solution, bearing in mind the need for minimal resistance to opening and closing movements. Drop seals can be face-fixed, semi-rebated or concealed within the bottom of the door leaf. For optimum acoustic performance a drop seal should be used with a threshold plate.



▲ LAS8001 si shown with LAS4001

## Icons used throughout this brochure:



indicates that the seals featured reduce the passage of sound.



indicates that the seals featured provide protection against cold smoke.



indicates that the seals featured provide protection against fire and hot smoke.



indicates that the seals are wheeled traffic friendly.



indicates that the seals featured provide thermal containment properties.







▼

# 29—30dB SOLUTIONS

SUITABLE FOR

Hotels / Student accommodation /  
Apartments / Commercial buildings /  
Schools

# 29dB

## LAS1212, LP1504 & LAS8001 si

SINGLE LEAF | SINGLE SWING |  
FLAXBOARD RAIL & STILE CONSTRUCTION | 44MM

### ACOUSTIC PERFORMANCE OF DOORSET\*

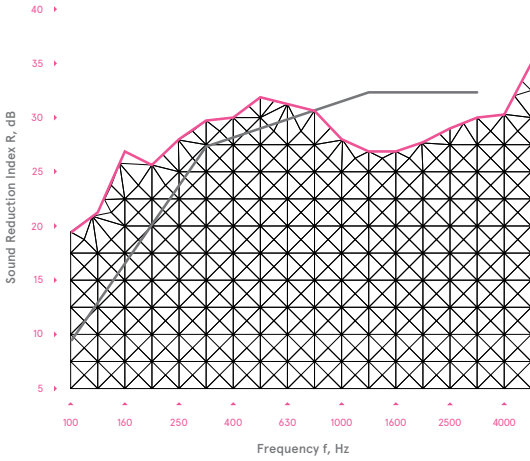

— SOUND REDUCTION INDEX  
Using components listed above

— CURVE OF REFERENCE VALUES (BS EN ISO 717-1: 2013)

\*Tested in accordance with BS EN ISO 10140-2: 2010



29dB SOLUTION

### SYSTEM COMPONENTS

Type	Product	Description	Key features	Performance
1 PERIMETER SEAL	LAS1212 Batwing®	Highly effective acoustic/smoke seal	<ul style="list-style-type: none"> <li>▶ Curved fins allow easier door operation</li> <li>▶ Fitted with minimal disruption to door</li> </ul>	<b>Acoustic</b> BS EN ISO 10140-2: 2010 <b>Smoke</b> BS 476: Pt.31.1: 1983 <b>Durability</b> 1 million cycles <b>CERTIFIRE</b> CF5179 UL R27972
2 PERIMETER SEAL	LP1504	Fire seal	<ul style="list-style-type: none"> <li>▶ Integral antimicrobial protection</li> </ul>	<b>Fire CERTIFIRE</b> BS 476: Pt.20/22: 1987 CF341, CF330
3 DROP SEAL	LAS8001 si	Durable acoustic/smoke/thermal drop seal	<ul style="list-style-type: none"> <li>▶ Mechanism lifts the seal clear of the floor when opened</li> <li>▶ Self-levelling works on uneven floors</li> </ul>	<b>Acoustic</b> BS EN ISO 10140-2: 2010 <b>Smoke</b> BS 9999 BS 476: Pt.31.1: 1983 <b>Fire</b> BS 476: Pt.20/22: 1987 BS EN 1634-1: 2014 <b>Durability</b> 1 million cycles <b>CERTIFIRE</b> CF5179 UL R27972



DESIGNED FOR:



www.lorientgroup.com



# 30dB

## LP1504 Finesse™ & LAS8002 si

SINGLE LEAF | SINGLE SWING |  
SOLID CHIPBOARD CORE | 44MM

### ACOUSTIC PERFORMANCE OF DOORSET\*

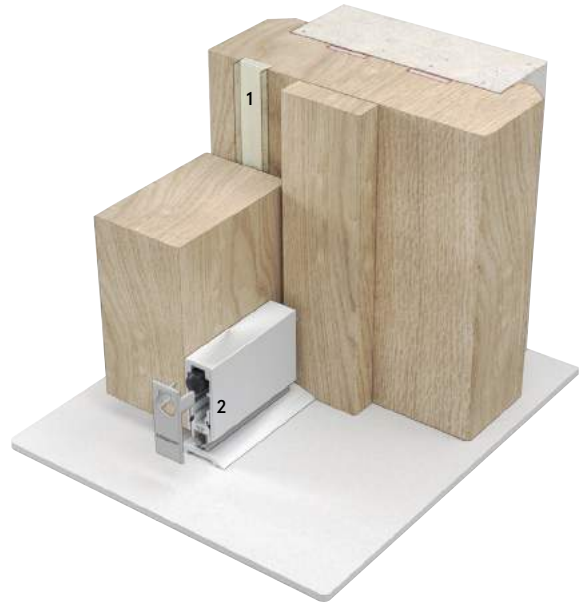
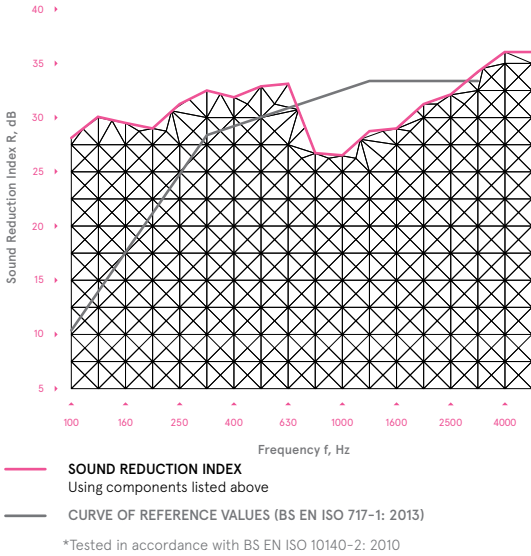

### SYSTEM COMPONENTS

Type	Product	Description	Key features	Performance
1 PERIMETER SEAL	LP1504 Finesse™	Combined acoustic/smoke/fire/thermal seal	<ul style="list-style-type: none"> <li>Superior aesthetics - transparent fins &amp; woodgrain finishes</li> <li>Offers continuous smoke seal</li> <li>Integral antimicrobial protection</li> </ul>	<b>Acoustic</b> BS EN ISO 10140-2: 2010 <b>Smoke</b> BS 476: Pt.31.1: 1983 <b>Fire</b> BS 476: Pt.20/22: 1987 BS EN 1634-1: 2014 <b>Durability</b> 1 million cycles <b>CERTIFIRE</b> CF341, CF330
2 DROP SEAL	LAS8002 si	Face-fixed or semi-mortised acoustic/smoke/thermal drop seal	<ul style="list-style-type: none"> <li>Mechanism lifts the seal clear of the floor when opened</li> <li>Upgrade existing doors</li> </ul>	<b>Acoustic</b> BS EN ISO 10140-2: 2010 <b>Smoke</b> BS 9999 BS 476: Pt.31.1: 1983 <b>Fire</b> BS 476: Pt.20/22: 1987 BS EN 1634-1: 2014 <b>Durability</b> 1 million cycles <b>CERTIFIRE</b> CF5179 UL R27972



DESIGNED FOR:



Acoustic Sealing Systems for Door Assemblies



# 31–34dB SOLUTIONS

SUITABLE FOR  
Schools (excluding music rooms) /  
Hotels / Apartments /  
Commercial buildings

# 31dB

## LAS7001 si, LAS1011, LAS8001 si & LAS4002

DOUBLE LEAF | SINGLE SWING |  
LAMINATED TIMBER CORE | 44MM

### ACOUSTIC PERFORMANCE OF DOORSET\*

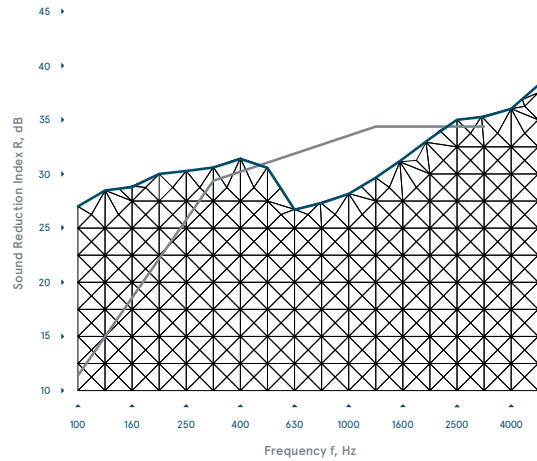

— SOUND REDUCTION INDEX  
Using components listed above

— CURVE OF REFERENCE VALUES (BS EN ISO 717-1: 2013)

\*Tested in accordance with BS EN ISO 10140-2: 2010



31dB SOLUTION

### SYSTEM COMPONENTS

Type	Product	Description	Key features	Performance
1 PERIMETER SEAL	LAS7001 si	Robust acoustic /smoke seal	<ul style="list-style-type: none"> <li>Designed to be fitted to existing door stops</li> </ul>	Acoustic Smoke Durability CERTIFIRE BS EN ISO 10140-2: 2010 BS 476: Pt.31.1: 1983 1 million cycles CF5179 UL R27972
2 MEETING STILE SEAL	LAS1011	Versatile acoustic /smoke seal	<ul style="list-style-type: none"> <li>Flexible durable fins</li> <li>Easy to fit</li> </ul>	Acoustic Smoke Durability CERTIFIRE BS EN ISO 10140-2: 2010 BS 476: Pt.31.1: 1983 1 million cycles CF5179 UL R27972
3 DROP SEAL	LAS8001 si	Durable acoustic/smoke/thermal drop seal	<ul style="list-style-type: none"> <li>Mechanism lifts the seal clear of the floor when opened</li> <li>Self-levelling works on uneven floors</li> </ul>	Acoustic Smoke Fire Durability CERTIFIRE BS EN ISO 10140-2: 2010 BS 9999 BS 476: Pt.31.1: 1983 BS 476: Pt.20/22: 1987 BS EN 1634-1: 2014 1 million cycles CF5179 UL R27972
4 THRESHOLD PLATE	LAS4002	Low-profile slimline plate	<ul style="list-style-type: none"> <li>Works with practically any threshold seal</li> <li>Can prevent rain, draught &amp; smoke penetration</li> </ul>	UL R27972



DESIGNED FOR:



Acoustic Sealing Systems for Door Assemblies

30dB SOLUTION

www.lorientgroup.com

# 32dB

## LAS1212, LP1504 x 2, LP1504DS x 2, LAS8001 si & LAS4002

DOUBLE LEAF | SINGLE SWING |  
SOLID CHIPBOARD CORE | 54MM

ACOUSTIC PERFORMANCE OF DOORSET\*

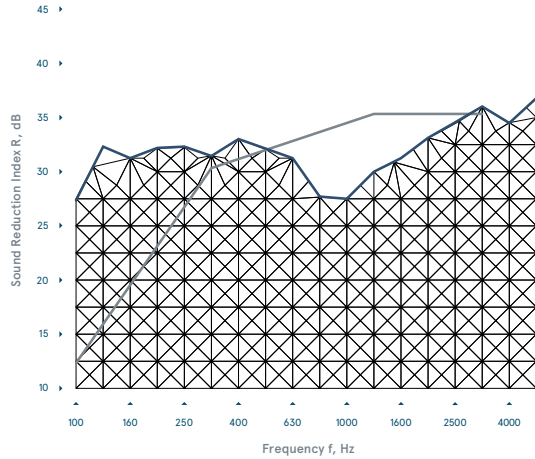

— SOUND REDUCTION INDEX  
Using components listed above

— CURVE OF REFERENCE VALUES (BS EN ISO 717-1: 2013)

\*Tested in accordance with BS EN ISO 10140-2: 2010

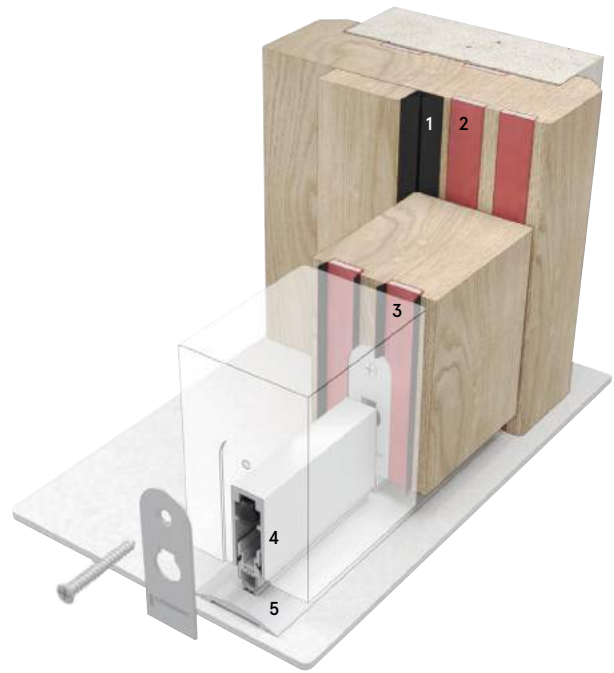

29dB SOLUTION

### SYSTEM COMPONENTS

Type	Product	Description	Key features	Performance
1 PERIMETER SEAL	LAS1212 Batwing®	Highly effective acoustic/smoke seal	<ul style="list-style-type: none"> <li>▶ Curved fin shape minimises open/closing resistance</li> <li>▶ Fitted with minimal disruption to door</li> </ul>	<b>Acoustic Smoke</b> BS EN ISO 10140-2: 2010 BS EN 1634-3: 2004 BS 476: Pt.31.1: 1983  <b>Durability CERTIFIRE</b> 1 million cycles CF5179 UL R27972
2 PERIMETER SEALS	LP1504 x 2	Fire seal	<ul style="list-style-type: none"> <li>▶ Integral antimicrobial protection</li> </ul>	<b>Fire CERTIFIRE</b> BS 476: Pt.20/22: 1987 CF341, CF330
3 MEETING STILE SEALS	LP1504DS x 2	Combined acoustic/smoke/fire/thermal seal	<ul style="list-style-type: none"> <li>▶ Exceptional low friction for ease of door operation</li> <li>▶ Integral antimicrobial protection</li> </ul>	<b>Acoustic Smoke Fire</b> BS EN ISO 10140-2: 2010 BS 476: Pt.31.1: 1983 BS 476: Pt.20/22: 1987 BS EN 1634-1: 2014  <b>Durability</b> 1 million cycles
4 DROP SEAL	LAS8001 si	Durable acoustic/smoke/thermal drop seal	<ul style="list-style-type: none"> <li>▶ Mechanism lifts the seal clear of the floor when opened</li> <li>▶ Self-levelling works on uneven floors</li> </ul>	<b>Acoustic Smoke</b> BS EN ISO 10140-2: 2010 BS 9999 BS 476: Pt.31.1: 1983  <b>Fire</b> BS 476: Pt.20/22: 1987 BS EN 1634-1: 2014  <b>Durability CERTIFIRE</b> 1 million cycles CF5179 UL R27972
5 THRESHOLD PLATE	LAS4002	Low-profile slimline plate	<ul style="list-style-type: none"> <li>▶ Works with practically any threshold seal</li> <li>▶ Can prevent rain, draught &amp; smoke penetration</li> </ul>	UL R27972



DESIGNED FOR:



32dB SOLUTION

# 33dB

## LP1504DS, LAS8001 si & FF1

SINGLE LEAF | SINGLE SWING | GLAZED |  
SOLID CHIPBOARD CORE | 44MM

### ACOUSTIC PERFORMANCE OF DOORSET\*

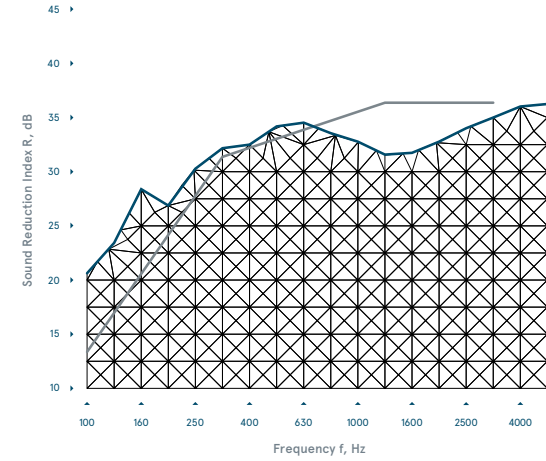

— SOUND REDUCTION INDEX  
Using components listed above

--- CURVE OF REFERENCE VALUES (BS EN ISO 717-1: 2013)

\*Tested in accordance with BS EN ISO 10140-2: 2010



33dB SOLUTION

### SYSTEM COMPONENTS

Type	Product	Description	Key features	Performance
1 PERIMETER SEAL	LP1504DS	Combined acoustic/smoke/fire/thermal seal	<ul style="list-style-type: none"> <li>▶ Exceptional low friction for ease of door operation</li> <li>▶ Offers continuous smoke seal</li> <li>▶ Integral antimicrobial protection</li> </ul>	<b>Acoustic</b> BS EN ISO 10140-2: 2010 <b>Smoke</b> BS 476: Pt.31.1: 1983 <b>Fire</b> BS 476: Pt.20/22: 1987 BS EN 1634-1: 2014 <b>Durability</b> 1 million cycles <b>CERTIFIRE</b> CF341, CF330
2 DROP SEAL	LAS8001 si	Durable acoustic/smoke/thermal drop seal	<ul style="list-style-type: none"> <li>▶ Mechanism lifts the seal clear of the floor when opened</li> <li>▶ Self-levelling works on uneven floors</li> </ul>	<b>Acoustic</b> BS EN ISO 10140-2: 2010 <b>Smoke</b> BS 9999 BS 476: Pt.31.1: 1983 <b>Fire</b> BS 476: Pt.20/22: 1987 BS EN 1634-1: 2014 <b>Durability</b> 1 million cycles <b>CERTIFIRE</b> CF5179 <b>UL</b> R27972
3 GLAZING SEAL	FF1	A pair of bead applied intumescent gaskets for 30 minutes fire resistance	<ul style="list-style-type: none"> <li>▶ Flexible, quick &amp; easy to install</li> <li>▶ Unique design – enables tolerances between door, bead &amp; glass thicknesses to be accommodated</li> </ul>	<b>Fire</b> BS 476: Pt.20/22: 1987 <b>CERTIFIRE</b> CF327 <b>Glass type</b> 1230 x 230 x 6mm Pyroshield™ 2



DESIGNED FOR:



Acoustic Sealing Systems for Door Assemblies

30dB SOLUTION

www.lorientgroup.com

# 33dB

## LAS1212, LAS1011, LAS1011 x 2, LAS8003 si, LAS4002 & System-36/7 PLUS

DOUBLE LEAF | SINGLE SWING | GLAZED | SOLID CHIPBOARD CORE | 44MM

### ACOUSTIC PERFORMANCE OF DOORSET\*

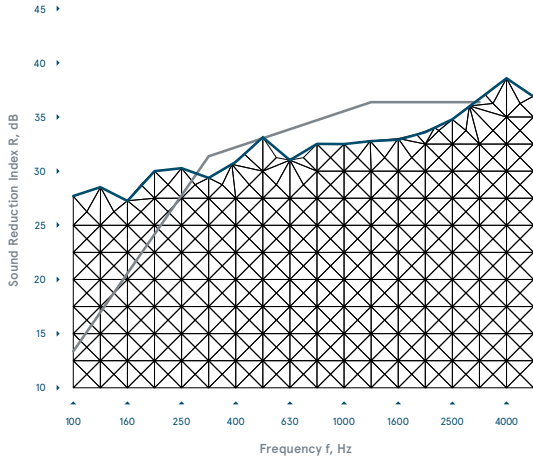

— SOUND REDUCTION INDEX  
Using components listed above

— CURVE OF REFERENCE VALUES (BS EN ISO 717-1: 2013)

\*Tested in accordance with BS EN ISO 10140-2: 2010



29dB SOLUTION

### SYSTEM COMPONENTS

Type	Product	Description	Key features	Performance
1 PERIMETER SEAL	LAS1212 Batwing®	Highly effective acoustic/smoke seal	<ul style="list-style-type: none"> <li>▶ Curved fin shape minimises open/closing resistance</li> <li>▶ Fitted with minimal disruption to door</li> </ul>	<b>Acoustic Smoke</b> BS EN ISO 10140-2: 2010 BS EN 1634-3: 2004 BS 476: Pt.31.1: 1983  <b>Durability CERTIFIRE</b> 1 million cycles CF5179 UL R27972
2 PERIMETER SEAL	LAS1011	Versatile acoustic/smoke seal	<ul style="list-style-type: none"> <li>▶ Flexible durable fins</li> <li>▶ Easy to fit</li> </ul>	<b>Acoustic Smoke</b> BS EN ISO 10140-2: 2010 BS 476: Pt.31.1: 1983  <b>Durability CERTIFIRE</b> 1 million cycles CF5179 UL R27972
3 MEETING STILE	LP1011 x 2	As above	▶ As above	As above
4 DROP SEAL	LAS8003 si	Face-fixed or semi-mortised acoustic/smoke/fire/thermal drop seal	<ul style="list-style-type: none"> <li>▶ Mechanism lifts the seal clear of the floor when opened</li> <li>▶ Self-levelling works on uneven floors</li> </ul>	<b>Acoustic Smoke</b> BS EN ISO 10140-2: 2010 BS 9999 BS 476: Pt.31.1: 1983  <b>Fire</b> BS 476: Pt.20/22: 1987 BS EN 1634-1: 2014  <b>Durability CERTIFIRE</b> 1 million cycles CF5179 UL R27972
5 THRESHOLD PLATE	LAS4002	Low-profile slimline plate	▶ Works with practically any threshold seal	UL R27972
6 GLAZING SEAL	System-36/7 PLUS	U-shaped, flexible intumescent glazing gasket	<ul style="list-style-type: none"> <li>▶ Suitable for fire resistant doors/screens</li> <li>▶ Flexible enough for circular vision panels</li> </ul>	<b>Fire Smoke CERTIFIRE</b> BS 476: Pt.20/22: 1987 BS EN 1634-1: 2008 CF5060  <b>Glass type</b> 1700 x 300 x 7mm Pyrodur® Plus



### DESIGNED FOR:



33dB SOLUTION

www.lorientgroup.com

# 34dB

## LP1504DS, LAS8001 si & FF1

SINGLE LEAF | SINGLE SWING | GLAZED |  
LAMINATED TIMBER CORE | 44MM

ACOUSTIC PERFORMANCE OF DOORSET\*

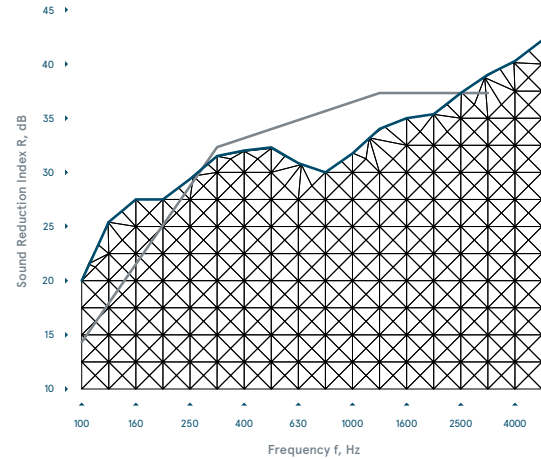

— SOUND REDUCTION INDEX  
Using components listed above

— CURVE OF REFERENCE VALUES (BS EN ISO 717-1: 2013)

\*Tested in accordance with BS EN ISO 10140-2: 2010



34dB SOLUTION

### SYSTEM COMPONENTS

Type	Product	Description	Key features	Performance
1 PERIMETER SEAL	LP1504DS	Combined acoustic/smoke/fire/thermal seal	<ul style="list-style-type: none"> <li>▶ Exceptional low friction for ease of door operation</li> <li>▶ Offers continuous smoke seal</li> <li>▶ Integral antimicrobial protection</li> </ul>	<b>Acoustic</b> BS EN ISO 10140-2: 2010 <b>Smoke</b> BS 476: Pt.31.1: 1983 <b>Fire</b> BS 476: Pt.20/22: 1987 BS EN 1634-1: 2014 <b>Durability</b> 1 million cycles <b>CERTIFIRE</b> CF341, CF330
2 DROP SEAL	LAS8001 si	Durable acoustic/smoke/thermal drop seal	<ul style="list-style-type: none"> <li>▶ Mechanism lifts the seal clear of the floor when opened</li> <li>▶ Self-levelling works on uneven floors</li> </ul>	<b>Acoustic</b> BS EN ISO 10140-2: 2010 <b>Smoke</b> BS 9999 BS 476: Pt.31.1: 1983 <b>Fire</b> BS 476: Pt.20/22: 1987 BS EN 1634-1: 2014 <b>Durability</b> 1 million cycles <b>CERTIFIRE</b> CF5179 UL R27972
3 GLAZING SEAL	FF1	A pair of bead applied intumescent gaskets for 30 minutes fire resistance	<ul style="list-style-type: none"> <li>▶ Flexible, quick &amp; easy to install</li> <li>▶ Unique design – enables tolerances between door, bead &amp; glass thicknesses to be accommodated</li> </ul>	<b>Fire</b> BS 476: Pt.20/22: 1987 <b>CERTIFIRE</b> CF327 <b>Glass type</b> 1230 x 230 x 15mm Fireswiss foam



DESIGNED FOR:



Acoustic Sealing Systems for Door Assemblies

30dB SOLUTION

www.lorientgroup.com





▼

# 35dB SOLUTIONS

SUITABLE FOR  
School music rooms / Private offices /  
Apartments / Consulting rooms



# 35dB

## LP1504DS x 2 & LAS8001 si

SINGLE LEAF | SINGLE SWING |  
LAMINATED TIMBER CORE | 54MM

ACOUSTIC PERFORMANCE OF DOORSET\*

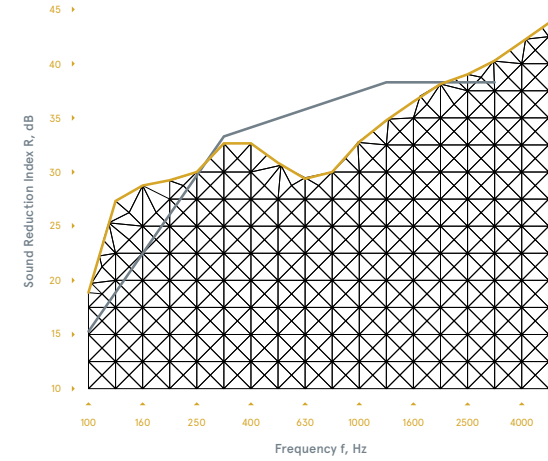

— **SOUND REDUCTION INDEX**  
Using components listed above

— **CURVE OF REFERENCE VALUES (BS EN ISO 717-1: 2013)**

\*Tested in accordance with BS EN ISO 10140-2: 2010



35dB SOLUTION

Type	Product	Description	Key features	Performance
1 PERIMETER SEALS	LP1504DS x 2	Combined acoustic/smoke/fire/thermal seal	<ul style="list-style-type: none"> <li>▶ Exceptional low friction for ease of door operation</li> <li>▶ Offers continuous smoke seal</li> <li>▶ Integral antimicrobial protection</li> </ul>	<b>Acoustic</b> BS EN ISO 10140-2: 2010 <b>Smoke</b> BS 476: Pt.31.1: 1983 <b>Fire</b> BS 476: Pt.20/22: 1987 BS EN 1634-1: 2014 <b>Durability</b> 1 million cycles <b>CERTIFIRE</b> CF341, CF330
2 DROP SEAL	LAS8001 si	Durable acoustic/smoke/thermal drop seal	<ul style="list-style-type: none"> <li>▶ Mechanism lifts the seal clear of the floor when opened</li> <li>▶ Self-levelling works on uneven floors</li> </ul>	<b>Acoustic</b> BS EN ISO 10140-2: 2010 <b>Smoke</b> BS 9999 BS 476: Pt.31.1: 1983 <b>Fire</b> BS 476: Pt.20/22: 1987 BS EN 1634-1: 2014 <b>Durability</b> 1 million cycles <b>CERTIFIRE</b> CF5179 UL R27972

ID No.  
72



30dB SOLUTION

www.lorientgroup.com

# 35dB

## LAS1212K, LP1504DS & LAS8001 si

SINGLE LEAF | SINGLE SWING | GLAZED |  
SOLID CHIPBOARD CORE | 44MM

### ACOUSTIC PERFORMANCE OF DOORSET\*

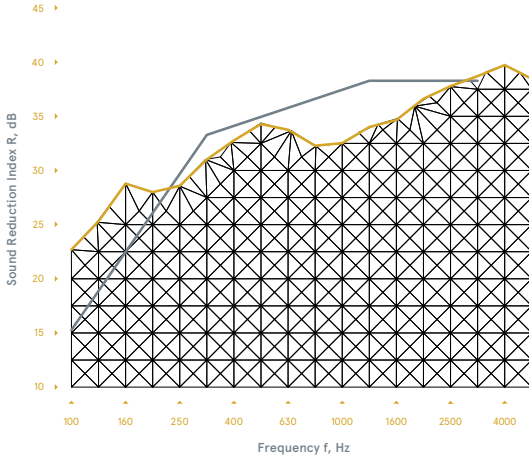

— SOUND REDUCTION INDEX  
Using components listed above

— CURVE OF REFERENCE VALUES (BS EN ISO 717-1: 2013)

\*Tested in accordance with BS EN ISO 10140-2: 2010



29dB SOLUTION

### SYSTEM COMPONENTS

Type	Product	Description	Key features	Performance
1 PERIMETER SEAL	LAS1212K Batwing®	Highly effective acoustic/smoke seal on-a-stick	<ul style="list-style-type: none"> <li>▶ Curved fin shape minimises open/closing resistance</li> <li>▶ Fitted with minimal disruption to door</li> </ul>	<b>Acoustic Smoke</b> BS EN ISO 10140-2: 2010 BS EN 1634-3: 2004 BS 476: Pt.31.1: 1983  <b>Durability CERTIFIRE</b> 1 million cycles CF5179 UL R27972
2 PERIMETER SEAL	LP1504DS	Combined acoustic/smoke/fire/thermal seal	<ul style="list-style-type: none"> <li>▶ Exceptional low friction for ease of door operation</li> <li>▶ Offers continuous smoke seal</li> <li>▶ Integral antimicrobial protection</li> </ul>	<b>Acoustic Smoke Fire</b> BS EN ISO 10140-2: 2010 BS 476: Pt.31.1: 1983 BS 476: Pt.20/22: 1987 BS EN 1634-1: 2014  <b>Durability CERTIFIRE</b> 1 million cycles CF341, CF330
3 DROP SEAL	LAS8001 si	Durable acoustic/smoke/thermal drop seal	<ul style="list-style-type: none"> <li>▶ Mechanism lifts the seal clear of the floor when opened</li> <li>▶ Self-levelling works on uneven floors</li> </ul>	<b>Acoustic Smoke Fire</b> BS EN ISO 10140-2: 2010 BS 9999 BS 476: Pt.31.1: 1983 BS 476: Pt.20/22: 1987 BS EN 1634-1: 2014  <b>Durability CERTIFIRE</b> 1 million cycles CF5179 UL R27972
4 GLAZING SEAL	System-36/15 PLUS	U-shaped intumescent glazing gasket	<ul style="list-style-type: none"> <li>▶ Suitable for fire resistant doors/screens</li> <li>▶ Flexible enough for circular vision panels</li> </ul>	<b>Fire Smoke CERTIFIRE Glass type</b> BS 476: Pt.20/22: 1987 BS EN 1634-1: 2008 CF5060 1530 x 300 x 15mm Pyrostop®



### DESIGNED FOR:



35dB SOLUTION

www.lorientgroup.com

# 35dB

## LAS1212, LAS1011, LAS1011 x 2, LAS1016 x 2 & LAS4002

DOUBLE LEAF | SINGLE SWING | LAMINATED TIMBER CORE | 54MM

ACOUSTIC PERFORMANCE OF DOORSET\*

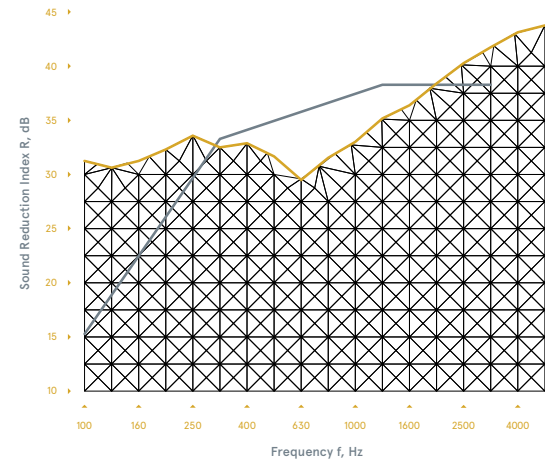

— SOUND REDUCTION INDEX  
Using components listed above

— CURVE OF REFERENCE VALUES (BS EN ISO 717-1: 2013)

\*Tested in accordance with BS EN ISO 10140-2: 2010



35dB SOLUTION

### SYSTEM COMPONENTS

Type	Product	Description	Key features	Performance
1 PERIMETER SEAL	LAS1212 Batwing®	Highly effective acoustic/smoke seal	<ul style="list-style-type: none"> <li>▶ Curved fin shape minimises open/closing resistance</li> <li>▶ Can be fitted with minimal disruption to door</li> </ul>	<b>Acoustic Smoke</b> BS EN ISO 10140-2: 2010 BS EN 1634-3: 2004 BS 476: Pt.31.1: 1983  <b>Durability CERTIFIRE</b> 1 million cycles CF5179 UL R27972
2 PERIMETER SEAL	LAS1011	Versatile acoustic/smoke seal	<ul style="list-style-type: none"> <li>▶ Flexible durable fins</li> <li>▶ Easy to fit</li> </ul>	<b>Acoustic Smoke</b> BS EN ISO 10140-2: 2010 BS EN 1634-3: 2004 BS 476: Pt.31.1: 1983  <b>Durability CERTIFIRE</b> 1 million cycles CF5179 UL R27972
3 MEETING STILE SEALS	LAS1011 x 2	As above	▶ As above	As above
4 DOOR BOTTOM SEALS	LAS1016 x 2	As above	▶ Flexible durable 6mm fins	As above
5 THRESHOLD PLATE	LAS4002	Low-profile slimline plate	<ul style="list-style-type: none"> <li>▶ Works with practically any threshold sea</li> <li>▶ Can prevent rain, draught &amp; smoke penetration</li> </ul>	UL R27972



DESIGNED FOR:



Acoustic Sealing Systems for Door Assemblies

30dB SOLUTION

www.lorientgroup.com

# 35dB

## LAS1212, LP1504DS & LAS8001 si

SINGLE LEAF | SINGLE SWING |  
SOLID CHIPBOARD CORE | 54MM

### ACOUSTIC PERFORMANCE OF DOORSET\*

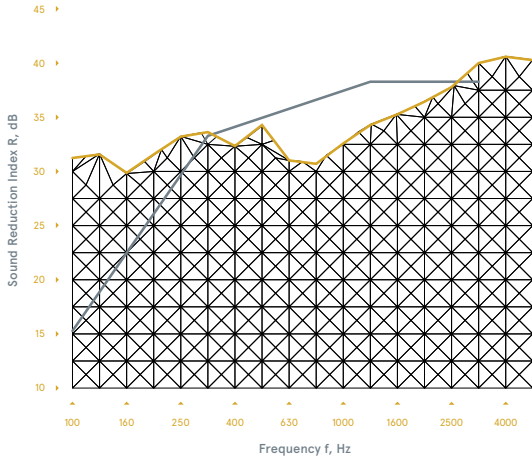

— SOUND REDUCTION INDEX  
Using components listed above

— CURVE OF REFERENCE VALUES (BS EN ISO 717-1: 2013)

\*Tested in accordance with BS EN ISO 10140-2: 2010



29dB SOLUTION

### SYSTEM COMPONENTS

Type	Product	Description	Key features	Performance
1 PERIMETER SEAL	LAS1212 Batwing®	Highly effective acoustic/smoke seal	<ul style="list-style-type: none"> <li>Curved fin shape minimises open/closing resistance</li> <li>Can be fitted with minimal disruption to door</li> </ul>	<b>Acoustic Smoke</b> BS EN ISO 10140-2: 2010 BS EN 1634-3: 2004 BS 476: Pt.31.1: 1983  <b>Durability CERTIFIRE</b> 1 million cycles CF5179 UL R27972
2 PERIMETER SEAL	LP1504DS	Combined acoustic/smoke/fire/thermal seal	<ul style="list-style-type: none"> <li>Exceptional low friction for ease of door operation</li> <li>Offers continuous smoke seal</li> <li>Integral antimicrobial protection</li> </ul>	<b>Acoustic Smoke Fire</b> BS EN ISO 10140-2: 2010 BS 476: Pt.31.1: 1983 BS 476: Pt.20/22: 1987 BS EN 1634-1: 2014  <b>Durability CERTIFIRE</b> 1 million cycles CF341, CF330
3 DROP SEAL	LAS8001 si	Durable acoustic/smoke/thermal drop seal	<ul style="list-style-type: none"> <li>Mechanism lifts the seal clear of the floor when opened</li> <li>Self-levelling works on uneven floors</li> </ul>	<b>Acoustic Smoke Fire</b> BS EN ISO 10140-2: 2010 BS 9999 BS 476: Pt.31.1: 1983 BS 476: Pt.20/22: 1987 BS EN 1634-1: 2014  <b>Durability CERTIFIRE</b> 1 million cycles CF5179 UL R27972

35dB SOLUTION



### DESIGNED FOR:



www.orientgroup.com

# 35dB

## LAS1212K, LP1504, AAS7506, LAS4014 si & System-36/15 PLUS

DOUBLE LEAF | SINGLE SWING | GLAZED |  
SOLID CHIPBOARD CORE | 54MM

### ACOUSTIC PERFORMANCE OF DOORSET\*

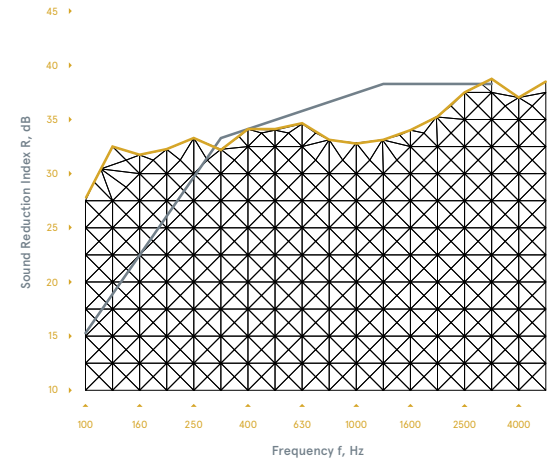

— SOUND REDUCTION INDEX  
Using components listed above

— CURVE OF REFERENCE VALUES (BS EN ISO 717-1: 2013)

\*Tested in accordance with BS EN ISO 10140-2: 2010



35dB SOLUTION

### SYSTEM COMPONENTS

Type	Product	Description	Key features	Performance
1 PERIMETER SEAL	LAS1212K Batwing®	Highly effective acoustic/smoke seal on-a-stick	<ul style="list-style-type: none"> <li>Curved fin shape minimises open/closing resistance.</li> <li>Fitted with minimal disruption to door</li> </ul>	<b>Acoustic Smoke</b> BS EN ISO 10140-2: 2010 BS EN 1634-3: 2004 BS 476: Pt.31.1: 1983  <b>Durability CERTIFIRE</b> 1 million cycles CF5179 UL R27972
2 PERIMETER SEAL	LP1504	Fire seal	<ul style="list-style-type: none"> <li>Integral antimicrobial protection</li> </ul>	<b>Fire CERTIFIRE</b> BS 476: Pt.20/22: 1987 CF341, CF330
3 MEETING STILE SEAL	AAS7506	Robust acoustic/smoke seal for use on plain/rebated meeting stiles	<ul style="list-style-type: none"> <li>Leg can be cut out to make way for locks &amp; latches</li> </ul>	<b>Acoustic Smoke</b> BS EN ISO 10140-2: 2010 BS EN 1634-3: 2004 BS 476: Pt.31.1: 1983  <b>Durability CERTIFIRE</b> 1 million cycles CF5179 UL R27972
4 THRESHOLD PLATE	LAS4014 si	Heavy duty threshold plate	<ul style="list-style-type: none"> <li>Helps resist rain, draught &amp; smoke penetration</li> </ul>	UL R27972
5 GLAZING SEAL	System-36/15 PLUS	U-shaped flexible intumescent glazing gasket	<ul style="list-style-type: none"> <li>Suitable for fire resistant doors/screens</li> <li>Flexible enough for circular vision panels</li> </ul>	<b>Fire Smoke CERTIFIRE Glass type</b> BS 476: Pt.20/22: 1987 BS EN 1634-1: 2008 CF5060 1570 x 300 x 15mm Pyrostop®



DESIGNED FOR:



Acoustic Sealing Systems for Door Assemblies

30dB SOLUTION

www.lorientgroup.com







▼

# 40dB+ SOLUTIONS

SUITABLE FOR

Recording studios / Auditoria /  
Theatres / Courts / Interview rooms

# 40dB

LP1504DS x 2, LP1504DS x 2, LP1504,  
LAS1016 x 2 & LAS4012

DOUBLE LEAF | DOUBLE SWING |  
LAYERED ACOUSTIC CORE | 54MM

ACOUSTIC PERFORMANCE OF DOORSET\*

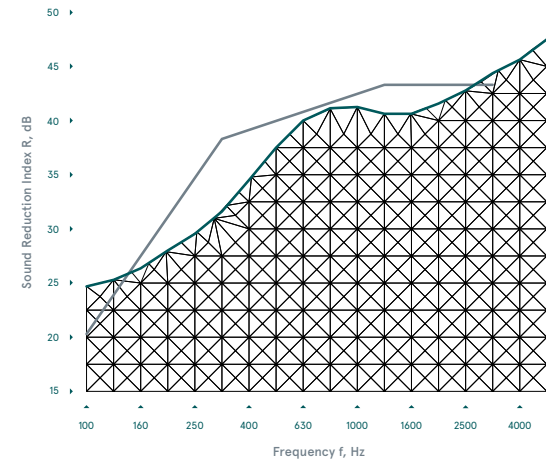

— SOUND REDUCTION INDEX  
Using components listed above

— CURVE OF REFERENCE VALUES (BS EN ISO 717-1: 2013)

\*Tested in accordance with BS EN ISO 10140-2: 2010



20dB SOLUTION

## SYSTEM COMPONENTS

Type	Product	Description	Key features	Performance
1 PERIMETER SEALS	LP1504DS x 2	Combined acoustic/smoke/fire/thermal seal	<ul style="list-style-type: none"> <li>▶ Exceptional low friction for ease of door operation</li> <li>▶ Offers continuous smoke seal</li> <li>▶ Integral antimicrobial protection</li> </ul>	<b>Acoustic</b> BS EN ISO 10140-2: 2010 <b>Smoke</b> BS 476: Pt.31.1: 1983 <b>Fire</b> BS 476: Pt.20/22: 1987 BS EN 1634-1: 2014 <b>Durability</b> 1 million cycles <b>CERTIFIRE</b> CF341, CF330
2 MEETING STILE SEALS	LP1504DS x 2	As above	▶ As above	As above
3 PERIMETER SEAL	LP1504	Fire seal	▶ Integral antimicrobial protection	<b>Fire</b> BS 476: Pt.20/22: 1987 <b>CERTIFIRE</b> CF341, CF330
4 DOOR BOTTOM SEALS	LAS1016 x 2	Versatile acoustic/smoke seal	<ul style="list-style-type: none"> <li>▶ Flexible durable 6mm fins</li> <li>▶ Easy to fit</li> </ul>	<b>Acoustic</b> BS EN ISO 10140-2: 2010 <b>Smoke</b> BS 9999 BS EN 1634-3: 2004 BS 476: Pt.31.1: 1983 <b>Durability</b> 1 million cycles <b>CERTIFIRE</b> CF5179
5 THRESHOLD PLATE	LAS4012	Medium duty low profile threshold plate	<ul style="list-style-type: none"> <li>▶ Only 6mm high ideal for wheeled traffic</li> <li>▶ Suitable for rain, draught &amp; smoke protection when used with a threshold seal</li> </ul>	UL R27972



DESIGNED FOR:



www.orientgroup.com



# 40dB

## LAS7003 si, LAS8001 si & LAS4014 si

SINGLE LEAF | SINGLE SWING |  
HIGH DENSITY ACOUSTIC CORE | 45MM

### ACOUSTIC PERFORMANCE OF DOORSET\*

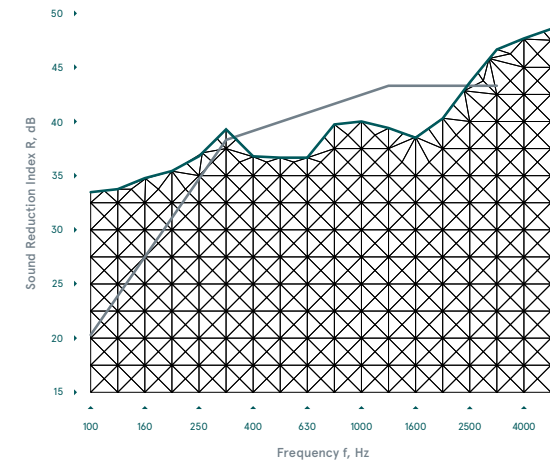

— SOUND REDUCTION INDEX  
Using components listed above

— CURVE OF REFERENCE VALUES (BS EN ISO 717-1:2013)

\*Tested in accordance with BS EN ISO 10140-2:2010



### SYSTEM COMPONENTS

Type	Product	Description	Key features	Performance
1 PERIMETER SEALS	LAS7003 si	Medium duty acoustic/smoke seal	<ul style="list-style-type: none"> <li>Seal is squeezed between door and frame, thus compensating for warped or unevenly hung doors.</li> </ul>	<b>Acoustic Smoke</b> BS EN ISO 10140-2: 2010 BS EN 1634-3: 2004 BS 476: Pt.31.1: 1983  <b>Durability CERTIFIRE</b> 1 million cycles CF5179 UL R27972
2 DROP SEAL	LAS8001 si	Durable acoustic/smoke/thermal drop seal	<ul style="list-style-type: none"> <li>Mechanism lifts the seal clear of the floor when opened</li> <li>Self-levelling works on uneven floors</li> </ul>	<b>Acoustic Smoke</b> BS EN ISO 10140-2: 2010 BS 9999 BS 476: Pt.31.1: 1983  <b>Fire</b> BS 476: Pt.20/22: 1987 BS EN 1634-1: 2014  <b>Durability CERTIFIRE</b> 1 million cycles CF341, CF330 UL R27972
3 THRESHOLD PLATE	LAS4014 si	A stepped threshold plate for effective acoustic sealing	<ul style="list-style-type: none"> <li>Silicone gasket enhances acoustic containment</li> <li>Acoustic bedding pads reduce vibration &amp; provide cushioning on uneven surfaces</li> </ul>	<b>Acoustic UL R27972</b> BS EN ISO 10140-2: 2010



DESIGNED FOR:



# 40dB

## LAS1212, LAS1011 x 2, LAS8001 si & LAS4014

DOUBLE LEAF | SINGLE SWING |  
HIGH DENSITY ACOUSTIC CORE | 45MM

ACOUSTIC PERFORMANCE OF DOORSET\*

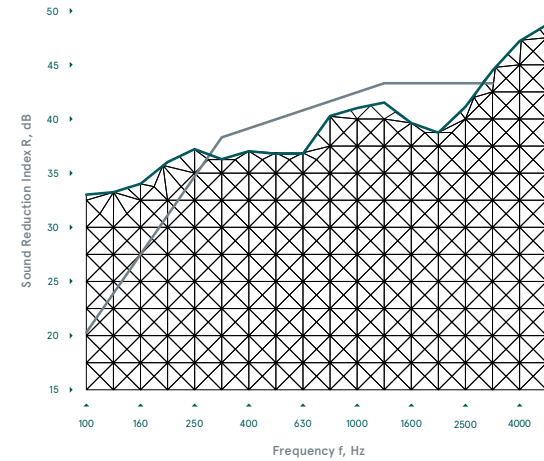

— SOUND REDUCTION INDEX  
Using components listed above

--- CURVE OF REFERENCE VALUES (BS EN ISO 717-1: 2013)

\*Tested in accordance with BS EN ISO 10140-2: 2010



20dB SOLUTION

### SYSTEM COMPONENTS

Type	Product	Description	Key features	Performance
1 PERIMETER SEAL	LAS1212 Batwing®	Highly effective acoustic/smoke seal	<ul style="list-style-type: none"> <li>▶ Curved fin shape minimises open/closing resistance</li> <li>▶ Fitted with minimal disruption to door</li> </ul>	<b>Acoustic Smoke</b> BS EN ISO 10140-2: 2010 BS EN 1634-3: 2004 BS 476: Pt.31.1: 1983  <b>Durability CERTIFIRE</b> 1 million cycles CF5179 <b>UL R27972</b>
2 MEETING STILE SEALS	LP1011 x 2	Versatile acoustic/smoke seal	<ul style="list-style-type: none"> <li>▶ Flexible durable fins</li> <li>▶ Easy to fit</li> </ul>	<b>Acoustic Smoke</b> BS EN ISO 10140-2: 2010 BS EN 1634-3: 2004 BS 476: Pt.31.1: 1983  <b>Durability CERTIFIRE</b> 1 million cycles CF5179 <b>UL R27972</b>
3 DROP SEAL	LAS8001 si	Durable acoustic/smoke/thermal drop seal	<ul style="list-style-type: none"> <li>▶ Mechanism lifts the seal clear of the floor when opened</li> <li>▶ Self-levelling works on uneven floors</li> </ul>	<b>Acoustic Smoke</b> BS EN ISO 10140-2: 2010 BS 9999 BS 476: Pt.31.1: 1983  <b>Fire</b> BS 476: Pt.20/22: 1987 BS EN 1634-1: 2014  <b>Durability CERTIFIRE</b> 1 million cycles CF5179 <b>UL R27972</b>
4 THRESHOLD PLATE	LAS4014 si	A stepped threshold plate for effective acoustic sealing	<ul style="list-style-type: none"> <li>▶ Silicone gasket enhances acoustic containment</li> <li>▶ Acoustic bedding pads reduce vibration &amp; provide cushioning on uneven surfaces</li> </ul>	<b>Acoustic</b> BS EN ISO 10140-2: 2010 <b>UL R27972</b>



DESIGNED FOR:



www.lorientgroup.com

# 41dB

## LAS1010, LP1504DS, LAS1011 x 2, LAS4010 & System-36/15 PLUS SINGLE LEAF | SINGLE SWING | GLAZED | LAYERED ACOUSTIC CORE | 44MM

ACOUSTIC PERFORMANCE OF DOORSET\*

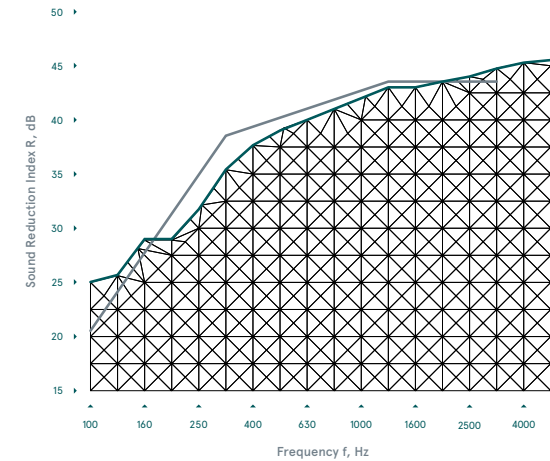

— SOUND REDUCTION INDEX  
Using components listed above

— CURVE OF REFERENCE VALUES (BS EN ISO 717-1: 2013)

\*Tested in accordance with BS EN ISO 10140-2: 2010



### SYSTEM COMPONENTS

Type	Product	Description	Key features	Performance
1 PERIMETER SEAL	LAS1010 Batwing®	Highly effective acoustic/smoke seal	<ul style="list-style-type: none"> <li>▶ Curved fin shape minimises open/closing resistance</li> <li>▶ Fitted with minimal disruption to door</li> </ul>	<b>Acoustic Smoke</b> BS EN ISO 10140-2: 2010 BS EN 1634-3: 2004 BS 476: Pt.31.1: 1983  <b>Durability CERTIFIRE</b> 1 million cycles CF5179 UL R27972
2 PERIMETER SEAL	LP1504DS	Combined acoustic/smoke/fire/thermal seal	<ul style="list-style-type: none"> <li>▶ Exceptional low friction for ease of door operation</li> <li>▶ Continuous smoke seal</li> <li>▶ Integral antimicrobial protection</li> </ul>	<b>Acoustic Smoke Fire</b> BS EN ISO 10140-2: 2010 BS 476: Pt.31.1: 1983 BS 476: Pt.20/22: 1987 BS EN 1634-1: 2014  <b>Durability CERTIFIRE</b> 1 million cycles CF5179
3 DOOR BOTTOM SEALS	LAS1016 x 2	Versatile acoustic/smoke seal	<ul style="list-style-type: none"> <li>▶ Flexible durable 6mm fins</li> <li>▶ Easy to fit</li> </ul>	<b>Acoustic Smoke</b> BS EN ISO 10140-2: 2010 BS 9999 BS EN 1634-3: 2004 BS 476: Pt.31.1: 1983  <b>Durability CERTIFIRE</b> 1 million cycles CF5179
4 THRESHOLD PLATE	LAS4010	Medium duty low profile threshold plate	<ul style="list-style-type: none"> <li>▶ Only 6mm high</li> <li>▶ Suitable for rain, draught &amp; smoke protection when used with a threshold seal</li> </ul>	UL R27972
5 GLAZING SEAL	System-36/15 PLUS	Flexible U-shaped intumescent gasket for 30 minute fire resistant doors/screens	<ul style="list-style-type: none"> <li>▶ Suitable for use with range of standard fixing beads</li> <li>▶ Flexible enough to be fitted to curved corners &amp; circular vision panels</li> </ul>	<b>Fire Smoke CERTIFIRE Glass type</b> BS 476: Pt.20/22: 1987 BS EN 1634-1: 2008 CF5060 1230x230x15mm Pyrostop®



DESIGNED FOR:



Acoustic Sealing Systems for Door Assemblies

# 41dB

LP1504DS x 2, LP1504DS x 2, LAS1016 x 2,  
LAS4010 & System-36/23 PLUS

DOUBLE LEAF | SINGLE SWING | GLAZED |  
LAYERED ACOUSTIC CORE | 59MM

ACOUSTIC PERFORMANCE OF DOORSET\*

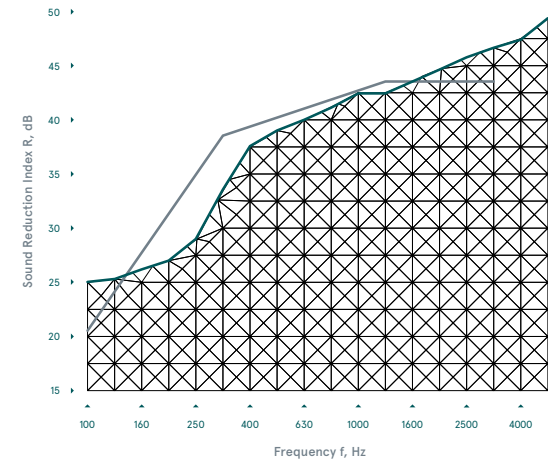

— SOUND REDUCTION INDEX  
Using components listed above

— CURVE OF REFERENCE VALUES (BS EN ISO 717-1: 2013)

\*Tested in accordance with BS EN ISO 10140-2: 2010

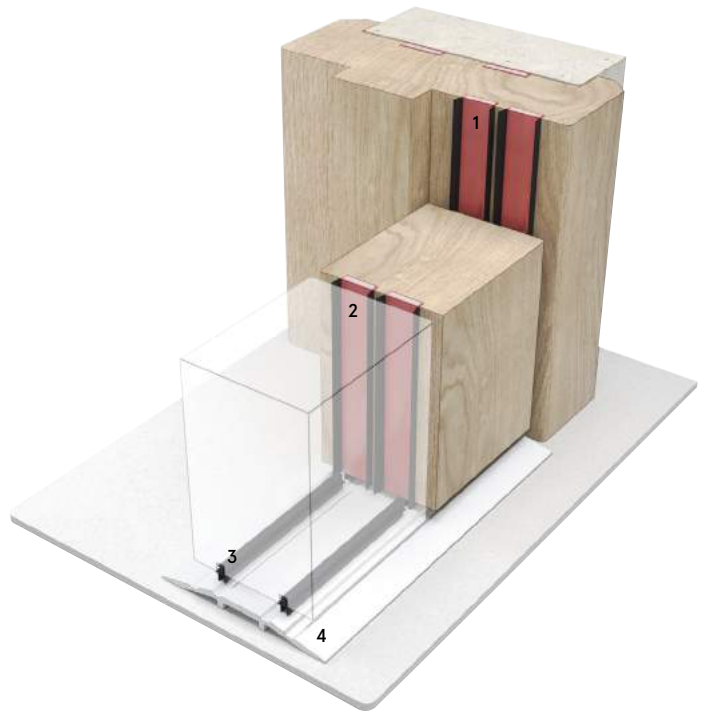

29dB SOLUTION

## SYSTEM COMPONENTS

Type	Product	Description	Key features	Performance
1 PERIMETER SEALS	LP1504DS x 2	Combined acoustic/smoke/fire/thermal seal	<ul style="list-style-type: none"> <li>▶ Exceptional low friction for ease of door operation</li> <li>▶ Offers continuous smoke seal</li> <li>▶ Integral antimicrobial protection</li> </ul>	<b>Acoustic</b> BS EN ISO 10140-2: 2010 <b>Smoke</b> BS 476: Pt.31.1: 1983 <b>Fire</b> BS 476: Pt.20/22: 1987 BS EN 1634-1: 2014 <b>Durability</b> 1 million cycles <b>CERTIFIRE</b> CF341, CF330
2 MEETING STILE SEALS	LP1504DS x 2	As above	▶ As above	As above
3 DOOR BOTTOM SEALS	LAS1016 x 2	Versatile acoustic/smoke seal	<ul style="list-style-type: none"> <li>▶ Flexible durable 6mm fins</li> <li>▶ Easy to fit</li> </ul>	<b>Acoustic</b> BS EN ISO 10140-2: 2010 <b>Smoke</b> BS 9999 BS EN 1634-3: 2004 BS 476: Pt.31.1: 1983 <b>Durability</b> 1 million cycles <b>CERTIFIRE</b> CF5179
4 THRESHOLD PLATE	LAS4010	Medium duty low profile threshold plate	<ul style="list-style-type: none"> <li>▶ Only 6mm high</li> <li>▶ Suitable for rain, draught &amp; smoke protection when used with a threshold seal</li> </ul>	UL R27972
5 GLAZING SEAL	System-36/23 PLUS	Flexible U-shaped intumescent gasket for 30 minute fire resistant doors/screens	▶ Suitable for use with range of standard fixing beads	<b>Smoke</b> BS EN 1634-1: 2008 <b>Fire</b> BS 476: Pt.20/22: 1987 <b>CERTIFIRE</b> CF5060 <b>Glass type</b> 1230x230x23mm Pyrostop®



DESIGNED FOR:



www.lorientgroup.com

# 43dB

## LAS1010, LP1504DS, LAS1016 x 2 & LAS4010

SINGLE LEAF | SINGLE SWING |  
LAYERED ACOUSTIC CORE | 44MM

### ACOUSTIC PERFORMANCE OF DOORSET\*

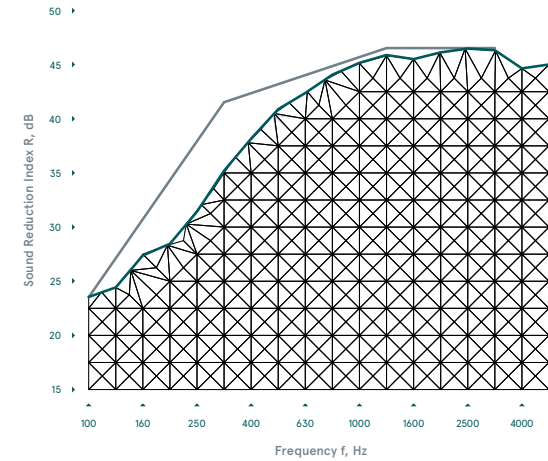

— SOUND REDUCTION INDEX  
Using components listed above

— CURVE OF REFERENCE VALUES (BS EN ISO 717-1: 2013)

\*Tested in accordance with BS EN ISO 10140-2: 2010



### SYSTEM COMPONENTS

Type	Product	Description	Key features	Performance
1 PERIMETER SEAL	LAS1010 Batwing®	Highly effective acoustic/smoke seal	<ul style="list-style-type: none"> <li>▶ Curved fin shape minimises open/closing resistance.</li> <li>▶ Fitted with minimal disruption to door</li> </ul>	<b>Acoustic Smoke</b> BS EN ISO 10140-2: 2010 BS EN 1634-3: 2004 BS 476: Pt.31.1: 1983  <b>Durability CERTIFIRE</b> 1 million cycles CF5179 <b>UL R27972</b>
2 PERIMETER SEAL	LP1504DS	Combined acoustic/smoke/fire/thermal seal	<ul style="list-style-type: none"> <li>▶ Exceptional low friction for ease of door operation</li> <li>▶ Offers continuous smoke seal</li> <li>▶ Integral antimicrobial protection</li> </ul>	<b>Acoustic Smoke Fire</b> BS EN ISO 10140-2: 2010 BS 476: Pt.31.1: 1983 BS 476: Pt.20/22: 1987 BS EN 1634-1: 2014  <b>Durability CERTIFIRE</b> 1 million cycles CF341, CF330
3 DOOR BOTTOM SEALS	LAS1016 x 2	Versatile acoustic /smoke seal	<ul style="list-style-type: none"> <li>▶ Flexible durable 6mm fins</li> <li>▶ Easy to fit</li> </ul>	<b>Acoustic Smoke</b> BS EN ISO 10140-2: 2010 BS 9999 BS EN 1634-3: 2004 BS 476: Pt.31.1: 1983  <b>Durability CERTIFIRE</b> 1 million cycles CF5179
4 THRESHOLD PLATE	LAS4010	Medium duty low profile threshold plate	<ul style="list-style-type: none"> <li>▶ Only 6mm high ideal for wheeled traffic</li> <li>▶ Suitable for rain, draught &amp; smoke protection when used with a threshold seal</li> </ul>	<b>UL R27972</b>



DESIGNED FOR:



Acoustic Sealing Systems for Door Assemblies





# TESTING + TECHNICAL SERVICES

We've built our reputation on the quality and dependability of our products, and our investment in R&D has played a pivotal role in keeping our products at the forefront of our industry. Our dedicated Testing and Technical Services division has established itself as an important facility for manufacturers and designers of doors, windows, glazing systems and hardware, to name just a few.

## TESTING SERVICES

Whether you're investigating new materials, or developing new or existing products, right through to durability testing and benchmarking performance – our team of experts will support you throughout the process. We are able to offer:

- ▶ Fire testing (indicative)
- ▶ Smoke leakage
- ▶ Air leakage
- ▶ ATG commissioning and maintenance for fire & smoke resisting air transfer grilles
- ▶ Mechanical cycling
- ▶ Environmental chamber analysis
- ▶ Attendance at external fire tests
- ▶ Consultancy services.

▲  
Lorient Indicative Furnace



# ADDITIONAL INFORMATION

## TECHNICAL REFERENCES

Lorient is quality assured under the disciplines of BS EN ISO 9001:2015.

Accreditation to this standard is an assurance that we conduct our business to the complete satisfaction of our customers with regard to design solutions, manufacturing consistency and management procedures.

As a result, this internationally recognised standard for quality management generates customer confidence. Regular audits of our company procedures are undertaken by qualified BSI staff to ensure ongoing compliance with all aspects of the standard.

Lorient has attained the BS EN ISO 14001:2015 accreditation for environmental management. This internationally recognised standard shows that we have demonstrated our commitment to responsible environmental behaviour, including prevention of pollution, control and reduction of waste, and ongoing monitoring and improvement of our environmental performance. Achieving ISO 14001 is just one part of our ongoing commitment to operate in a sustainable way.

## FITTING INSTRUCTIONS

Comprehensive fitting instructions are available to download from our website [www.lorientuk.com](http://www.lorientuk.com)

## MAINTENANCE

Periodic inspection/cleaning is recommended for all types of seals. The appearance and performance of brush seals will benefit from a wipe with a damp cloth at least once a year. Worn or damaged seals should be replaced without delay.

## COMPATIBILITY

All Lorient Architectural Seals are compatible with the materials normally used in doors and door frames, including wood, steel, PVC, aluminium and glass.

Please Note: Recommendations as to methods, use of materials and construction details are based on the experience and knowledge of Lorient and are given in good faith as a general guide and a service to designers, contractors and manufacturers.

## GUARANTEE OF ORIGIN

Each production batch of Lorient seals is laser engraved unobtrusively on the edge of the profile with the Lorient name and a code reference. This ensures the product and details of its production can be traced should the need arise.

**Unidentifiable substitute products should never be accepted.**

## MADE IN BRITAIN

We are proud to have been granted the prestigious Made in Britain marque for our products, designed and manufactured at our main facility in South West of the UK.



## INTELLECTUAL PROPERTY

© 2024 ASSA ABLOY Ltd T/A Lorient. Lorient is a registered trade mark of ASSA ABLOY LIMITED in England.

This brochure is protected by copyright and neither the drawings nor the text may be reproduced or transmitted in any form without prior consent from Lorient. Lorient products described in this brochure are protected by patents and design registrations in Great Britain and other countries.

We are committed to continually enhancing and improving our product range. We reserve the right to change product specifications from time to time without prior notice. E&OE.

June 2024.

## TRADE ASSOCIATIONS

Lorient is a member and active contributor to the following:



## ACCREDITATIONS

### BBA

BBA approvals provide independent assurance for the designer, specifier and end-user as to the 'fitness for purpose' of building products.

### CERTIFIRE

Operated by Exova Warringtonfire, CERTIFIRE is an accredited independent product conformity scheme that requires products to meet the requirements of the tests, to add minimal resistance to opening and closing forces, to prove long term performance under a variety of service conditions, and to be permanently marked for easy identification.

### IFC

IFC Certification Ltd is a UKAS approved and internationally recognised provider of third party Certification services – designed to give confidence to specifiers, users, occupiers, owners and enforcement bodies that products have been thoroughly and independently evaluated and will continue to be manufactured to the same specification as originally tested.

### UL

UL is a global independent safety science company that tests a diverse range of products; representative samples of a product must be tested and meet UL's stringent requirements to carry the marque. These requirements are based primarily on UL's published and nationally recognised Standards for Safety. Businesses, consumers and regulatory authorities around the world recognise the trusted rigour and technical excellence of UL certifications. Lorient is proud to have achieved the UL Mark on many of its products. These are detailed on individual pages.

# CPDs

We offer three fully-accredited CPD seminars. Impartially presented by knowledgeable speakers, the seminars are structured to be technically informative, and provide practical advice.

## Performance Door Design: The Basics of Sound Reduction

Effective acoustic containment helps to improve the quality of the built environment, preserving privacy as well as excluding unwanted noise. With changing regulations, it's essential to be informed of the relevant requirements and the implications for door assemblies.

Our acoustic CPD seminar covers:

- ▶ the nature of sound, examining airborne transmission of sound;
- ▶ regulatory requirements and British Standards that relate to acoustic performance;
- ▶ test procedures and interpretation of test reports;
- ▶ effective design of door assemblies for acoustic performance, including door construction and the influence of sealing systems;
- ▶ design conflicts between acoustic performance, durability and ease of operation of the door;
- ▶ independent accreditation.

## The Role and Performance of Fire and Smoke-Resisting Door Assemblies

The importance of fire and smoke resisting door assemblies is illustrated by the 216 fire related fatalities and 5,545 casualties in fires (England 2022/23). Apart from the human toll, property losses each year approach £2.52 billion.

Our fire and smoke containment CPD seminar covers:

- ▶ hard facts concerning deaths, injuries and property damage caused by fire and smoke;
- ▶ regulatory requirements for fire and smoke resisting door assemblies;
- ▶ the nature and behaviour of smoke;
- ▶ effective design of door assemblies for smoke containment, including the threshold gap;
- ▶ design conflicts between fire containment, smoke containment, durability and ease of operation of the door;
- ▶ independent accreditation.

## The Regulatory Reform (Fire Safety) Order 2005 and its implications for fire doors

The RRO consolidated 70 pieces of legislation; shifted responsibility for fire safety management; abolished the Fire Safety Certificate; established the Fire Risk Assessment and created major change in legal liability.

Our RRO CPD seminar covers:

- ▶ an overview of the RRO;
- ▶ product solutions;
- ▶ the dangers of fire and smoke;
- ▶ the importance of fire doors – including installation and maintenance.

Our CPD materials have been independently verified and certified by the RIBA as CPD approved. A certificate for 1 hour's CPD will be provided, which contributes to Continuing Professional Development requirements.

If you are interested in booking a seminar, please contact our Marketing department or email [cpd@lorientuk.com](mailto:cpd@lorientuk.com)



# AIR TRANSFER GRILLE CPD WEBINAR

We're delighted to offer a CPD entitled:  
The Specification + Design of Air Transfer Grilles / Dampers.

This is a fantastic addition to our growing collection of CPD seminars and explores:

- ▶ the latest test standards and building regulations;
- ▶ the major difference between intumescent air transfer grilles and dampers;
- ▶ the importance of correct specification, installation and maintenance;
- ▶ plus it offers practical solutions to fire and smoke containment over a range of applications.

All of our CPD seminars are available to view virtually, please visit [www.lorientuk.com](http://www.lorientuk.com) or email [cpd@lorientuk.com](mailto:cpd@lorientuk.com) for more information.



# COMPREHENSIVE SUPPORT

We continue to lead the way in Research + Development. As a company we have over 40 years' experience, so our experts are well equipped to listen, help and advise you on your sealing system requirements.

## Technical Services

We're happy to provide specialist advice on acoustic, smoke and fire protection for refurbishment and new build projects. If you need assistance, you can call our Technical Services team.

Alternatively, we can arrange a site visit to get a clearer idea of your needs and how we can help you. We also provide copies of test reports and samples where needed; and can give guidance on how best to meet Building Regulations and Standards.

## Web Support

Our website features a comprehensive range of supporting documents covering the entire range of products, including installation guides and CAD drawings. All of our brochures and products sheets are also available for download, together with copies of certification and specification texts.

## Online Acoustic Search tool

Our Acoustic Search tool on our website gives you quick and easy access to a wide range of tested acoustic sealing systems on a variety of popular door constructions & configurations.

[www.lorientuk.com/acousticsearch](http://www.lorientuk.com/acousticsearch)

The tool allows users to select a specific decibel rating; along with door configuration, fire door rating, doorset type etc to filter the results. The 'Acoustic Search' tool is updated frequently with Lorient's ever-expanding portfolio of test evidence. If you're looking for high performance or specialist applications – please contact us on **+44 (0) 1626 834252**, there may be some additional configurations we haven't yet published.

## Customisation

If you have a particular requirement which isn't covered by the applications in this brochure, we may be able to supply an existing non-standard item, or even develop a customised solution for you. Utilising in-house expertise, bespoke products are created to your requirements; from a functional or aesthetic perspective, or both.

Lorient's dedicated Technical Services team supports and works as part of your design team, offering informed product advice and guidance on regulatory requirements and standards.



**Call our Technical Services team**

**+44 (0) 1626 834252**

[www.lorientuk.com](http://www.lorientuk.com)

---

# SEALING SOLUTIONS

Detailed information about our products can be found in the following brochures:

## Lorient Architectural Seals

A variety of door sealing systems including perimeter seals, drop seals, threshold plates, door bottom seals and many more.

## Fire, Smoke and Acoustic Seals for Door Assemblies

Our core range of high performance fire, smoke and acoustic seals.

## Fire and Smoke Resistant Air Transfer Grilles

A comprehensive range of intumescent air transfer grilles for doors, walls, ducts, floors and ceilings.

## Fire Resistant Door Hardware Protection

Letterplates, door viewers, door edge protectors and intumescent kits that can safely be installed into fire rated doors without compromising the fire/smoke performance.

## Fire Resistant Glazing Systems

Fire resistant glazing systems for doors, screens and partitions

## Acoustic Sealing Systems for Door Assemblies

A comprehensive series of acoustic sealing systems for various types of door construction.

Copies of these brochures are available by calling **+44 (0)1626 834252** or download from our website **[www.lorientuk.com](http://www.lorientuk.com)**



T I C  
G  
M S



**UK / EUROPE**

T: +44 (0) 1626 834252  
E: sales@lorientuk.com

**AUSTRALIA**

T: +61 (0) 3 8574 3888  
E: customerservice.au@assaabloy.com

**SINGAPORE**

T: +65 6880 0000  
E: sales.lorient@assaabloy.com

**HONG KONG**

T: +852 2260 0888  
E: sales@lorienthk.com

**UAE**

T: +971 4 8804888  
E: mktg@lorientuk.com

**USA**

T: +1 859 252 7441  
E: info@lorientna.com

For further information about  
Lorient products please visit:  
[www.lorientgroup.com](http://www.lorientgroup.com)